



ELECTRICAL COMPONENTS

Cable Glands & Accessories

- Plastic, Brass, Stainless Steel
- EMC ▪ Locknuts ▪ Plugs
- Ventilation Elements
- Thread Adaptors
- Sealing Washers
- Multi-hole Seals



Cable Glands & Accessories

This catalog features ITC’s extensive range of liquid-tight, strain relief cable glands (cord connectors) and accessories, including locknuts, sealing washers, plugs, etc. These cable glands suit most industrial applications such as switchgear manufacturing, automation and control panels, machine tools, instrumentation, and anywhere else a reliable, liquid-tight and pull-resistant seal is required when running cables and wires from an enclosure to the external environment.

ITC’s cable glands are available in an array of styles and colours, and in the most popular threads including Metric, NPT and Pg. These glands are designed to accommodate a wide variety of cable diameters, from approximately 2mm-63mm (0.08-2.50”), and most models are IP68 rated for immersion in water and still maintain a liquid-tight seal. The majority of models carry UL, CSA and VDE certifications.

ITC’s plastic glands are made of polyamide 6 (or PA6). Plastic locknuts are made of PA6 reinforced with 33% fiberglass. Standard colours are Black (similar to RAL9005) or light grey (similar to RAL7035). Other colours are available upon request for most polyamide glands.

Brass glands and locknuts are made of brass, nickel plated for optimal resistance to corrosion.

Stainless steel glands in select sizes are made in 303 SS. Internal seals are made of neoprene (synthetic rubber). See page 35 for more detailed characteristics of these materials.

New items to be found in this catalogue include brass glands for extra-large diameters of wires, Type ‘S’ glands, and Stainless Steel glands.

INDEX

- Plastic Glands with Standard & Reducing Seals NPT 3
- Plastic Glands with Standard & Reducing Seals Metric 4
- Plastic Glands with Standard & Reducing Seals Pg 6
- Plastic Glands with Long Thread- Metric & Pg 7
- Flex Protect Spiral Plastic Glands with Standard & Reducing Seals 8
- Elbow Plastic Glands & Elbow Plastic Connectors 10
- Brass Glans with Standard & Reducing Seals - NPT 11
- Brass Glands with Standard & Long Thread - Metric 12
- Brass Glands with Standard & Long Thread - Pg 13
- Brass Glands with Standard & Reducing Seals - Metric & Pg 14
- Large Head Brass Glands with Long Thread - Metric 15
- Stainless Steel Glands with Standard & Reducing Seals - Metric & NPT 16
- EMC Metal Glands 18
- Ventilation Glands & Ventilation Plugs - Metric & Pg 19
- Accessories - Plastic Locknuts 22
- Accessories - Brass Locknuts 24
- Accessories - Stainless Steel Locknuts 25
- Accessories - Threaded Stopping Plugs 26
- Accessories - Snap Bushings & Plugs 28
- Accessories - Sealing Washers & O-Rings 29
- Accessories - Multi-Hole Seals 30
- Accessories - Flat & Custom Cable Seals 32
- Accessories - Special Seals for ASI Cables; Hole Plugs & Temporary Sealing Plugs 33
- Ingress Protection (IP) 34
- Characteristics of Plastic Materials 35
- Thread Tables with recommended cut-out sizes 36
- Split Cable Glands 37
- Thread Adapters 38

Plastic Glands - NPT







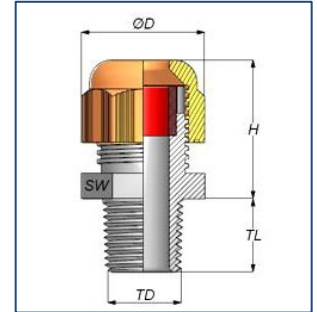



Standard liquid-tight polyamide (plastic) strain-relief connectors are used in most industrial applications for protecting and sealing a cable or wire in the transition across a panel or machine wall. ITC offers 2 versions of these glands, regular and Type 'S' (S as last character of part number), the dimensions of the two vary.

Features and specifications:

	Regular	Type S
Operating Temperature: Permanent	-20 to 100 °C	-40 to 100 °C
Intermittent	-30 to 150 °C	-40 to 150 °C
Ingress Protection	IP68 @5 Bar	
Material: Body and dome	Polyamide 6	Polyamide 6
Seal	Chloroprene	Neoprene













Plastic NPT Glands with Standard Seal (Order by Part No.)

NPT	Part Number		Cert.	Cable Range		Gland Dimensions (mm)				Gland Dimensions (in)				P a c k
	Light Grey	Black		mm	in	TD	TL	H	ØD	TD	TL	H	ØD	
3/8" NPT	180.038	180.138		5-10	0.197-0.394	17.1	15	32.0	25.0	0.67	0.59	1.263	0.98	50
3/8" NPT	—	180.138S		2.5-8	0.098-0.315	17.1	11	27.0	22.0	0.67	0.43	1.06	0.75	50
1/2" NPT	180.050	180.150		6-12	0.236-0.472	21.2	15	32.4	27.0	0.84	0.59	1.276	1.06	50
1/2" NPTL	182.050	182.150		10-14	0.394-0.551	21.2	15	32.0	30.9	0.84	0.59	1.263	1.22	50
1/2" NPT	—	180.150S		5-12	0.197-0.472	21.3	14	30.0	27.5	0.84	0.55	1.18	0.94	50
3/4" NPT	182.075	182.175		13-18	0.511-0.709	26.6	15	38.4	37.0	1.05	0.59	1.51	1.464	25
3/4" NPT	—	182.175S		9-18	0.354-0.709	26.6	15	39	37.0	1.05	0.59	1.54	1.30	20
1" NPT	180.091	180.191		18-25	0.709-0.984	33.2	18	43.3	47.1	1.31	0.709	1.705	1.85	20
1" NPT	—	182.191S		14-25	0.551-0.984	33.2	18	42	46.0	1.31	0.71	1.65	1.65	20
1 1/4" NPT	—	180.194		22-32	0.866-1.260	42.0	18	53.0	53.0	1.65	0.709	2.087	2.087	10

Information subject to change without notice - All dimensions in mm except where indicated. See page 36 for recommended cut-out sizes

Plastic NPT Glands with Reducing Seal (Order by Part No.)

NPT	Part Number		Cert.	Cable Range		Gland Dimensions (mm)				Gland Dimensions (in)				P a c k
	Light Grey	Black		mm	in	TD	TL	H	ØD	TD	TL	H	ØD	
3/8" NPT	181.038	181.138		3-7	0.118-0.276	17.1	15	32.2	25.2	0.67	0.59	1.140	0.98	50
3/8" NPT	—	181.138S		1.5-6	0.059-0.236	17.1	11	27.0	22.0	0.67	0.43	1.50	0.75	50
1/2" NPT	181.050	181.150		5-9	0.197-0.354	21.2	15	32.4	27.0	0.84	0.59	1.276	1.069	50
1/2" NPTL	183.050	183.150		7-12	0.276-0.472	21.2	15	32.0	31.0	0.84	0.59	1.263	1.22	50
1/2" NPT	—	181.150S		3-9	0.118-0.354	21.2	14	30.0	27.5	0.84	0.55	1.73	0.94	50
3/4" NPT	183.075	183.175		9-16	0.354-0.630	26.6	15	38.4	37.2	1.05	0.59	1.51	1.465	25
3/4" NPT	—	183.175S		7-16	0.276-0.630	26.6	15	39.0	37	1.05	0.59	2.13	1.30	20
1" NPT	181.091	181.191		12-20	0.472-0.787	33.2	18	43.3	47.1	1.31	0.709	1.705	1.85	20
1" NPT	—	181.191S		11-21	0.433-0.827	33.2	18	42.0	46.5	1.31	0.71	2.36	1.65	20
1 1/4" NPT	—	181.194		20-26	0.787-1.024	42.0	18	51.5	53.0	1.65	0.709	2.087	2.087	10

Information subject to change without notice - All dimensions in mm except where indicated. See page 36 for recommended cut-out sizes



Plastic Glands- Metric

Standard liquid-tight polyamide (plastic) strain-relief connectors are used in most industrial applications for protecting and sealing a cable or wire in the transition across a panel or machine wall. ITC offers 2 versions of these glands, regular and Type 'S' (S as last character of part number), the dimensions of the two vary.



Features and specifications:

	Regular	Type S
Operating Temperature: Permanent Intermittent	-20 to 100° C -30 to 150° C	-40 to 100° C -40 to 150° C
Ingress Protection	IP68 @5 Bar	
Material: Body and dome Seal	Polyamide 6 Chloroprene	Polyamide 6 Neoprene

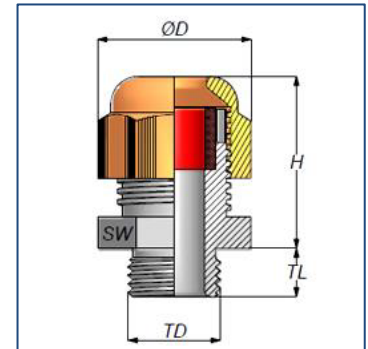

Plastic Metric Glands with Standard Seal (Order by Part No.)

M	Part Number		Cert.	Cable Range		Gland Dimensions (mm)				Pack
	Light Grey	Black		mm	Inches	TD	TL	H	ØD	
M12x1.5	180.012	180.112	CS, UL, US	3-6.5	0.118-0.256	12	8	25.3	17.0	100
M12x1.5	180.012S	180.112S	c, UL, US	2.5-6.5	0.098-0.256	12	8	32	-	50
M16x1.5	180.017	180.117	CS, UL, US	5-10	0.197-0.394	16	10	32.2	25.0	50
M16x1.5	-	180.117S	c, UL, US	2.5-8	0.098-0.315	16	10	27	28.0	50
M20x1.5	180.020	180.120	CS, UL, US	6-12	0.236-0.472	20	10	32.4	27.0	50
M20x1.5	-	180.120S	c, UL, US	5-12	0.197-0.472	20	10	33	32.5	50
M20x1.5	182.020	182.120	CS, UL, US	10-14	0.394-0.551	20	10	31.9	30.9	50
M20x1.5	-	182.120S	c, UL, US	7-14	0.276-0.551	20	10	33	30.5	50
M25x1.5	180.025	180.125	CS, UL, US	13-18	0.512-0.709	25	10	38.4	37.2	25
M25x1.5	-	180.125S	c, UL, US	9-18	0.354-0.709	25	10	39	37.9	20
M32x1.5	180.032	180.132	CS, UL, US	18-25	0.709-0.984	32	15	43.3	47.1	20
M32x1.5	-	180.132S	c, UL, US	14-25	0.551-0.984	32	10	42	47.4	20
M40x1.5	180.040	180.140	CS, UL, US	22-32	0.866-1.260	40	18	52.4	59.6	10
M40x1.5	-	180.140S	c, UL, US	18-32	0.709-1.260	40	10	52	60.0	20
M50x1.5	180.051	180.151	CS, UL, US	30-38	1.181-1.496	50	18	54.8	67.8	10
M50x1.5	-	180.151S	c, UL, US	24-38.5	0.945-1.516	50	12	55	70.2	10
M63x1.5	180.063	180.163	CS, UL, US	34-44	1.133-1.732	63	18	54.9	72.4	10
M63x1.5	-	180.163S	c, UL, US	35-48	1.380-1.890	63	12	55	78.2	5
M75x2	-	180.174	c, UL, US	48-55	1.889-2.165	75	25	55	89.0	5

Information subject to change without notice - All dimensions in mm except where indicated. See page 36 for recommended cut-out sizes



Plastic Metric Glands with Reducing Seal (Order by Part No.)

M	Part Number		Cert.	Cable Range		Gland Dimensions (mm)				Pack
	Light Grey	Black		mm	Inches	TD	TL	H	ØD	
M12x1.5	181.012	181.112		2-5	0.079-0.197	12	8	25.3	17.0	100
M16x1.5	181.017	181.117		3-7	0.118-0.276	16	10	32.2	25.0	50
M16x1.5	—	181.116S		2-7	0.079-0.276	16	10	29	28	50
M20x1.5	181.020	181.120		5-9	0.197-0.354	20	10	32.4	27.0	50
M20x1.5	183.020	183.120		7-12	0.276-0.472	20	10	31.9	30.9	50
M20x1.5	—	181.120S		3-9	0.118-0.354	20	10	40	24	50
M25x1.5	181.025	181.125		9-16	0.354-0.630	25	10	38.4	37.2	25
M25x1.5	—	181.125S		7-16	0.276-0.630	25	10	39	37.9	20
M32x1.5	181.032	181.132		12-20	0.472-0.787	32	15	43.3	47.1	20
M32x1.5	—	181.132S		11-21	0.433-0.827	32	10	42	47.2	20
M40x1.5	181.040	181.140		20-26	0.787-1.024	40	18	52.4	59.6	10
M40x1.5	—	181.140S		13-26	0.512-1.024	40	10	52	60.0	20
M50x1.5	181.051	181.151		25-31	0.984-1.220	50	18	54.8	67.8	10
M50x1.5	—	181.151S		17-31	0.669-1.220	50	12	55	70.2	10
M63x1.5	181.063	181.163		29-35	1.142-1.378	63	18	54.9	72.4	10
M63x1.5	—	181.163S		26-39	1.234-1.535	63	12	55	78.2	5

Information subject to change without notice - All dimensions in mm except where indicated. See page 36 for recommended cut-out sizes







Plastic Glands - Pg

Standard liquid-tight polyamide (plastic) strain-relief connectors are used in most industrial applications for protecting and sealing a cable or wire in the transition across a panel or machine wall.

Features and specifications:

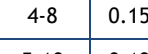
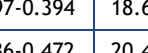
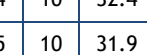
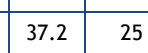
- **Operating Temperature:** -20 to 100°C (permanent), -30 to 150°C (intermittent)
- **Ingress Protection:** IP68 @ 5 bar
- **Material:** Body and dome: Polyamide 6, Seal: Chloroprene





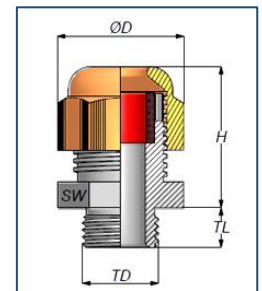





Plastic Pg Glands with Standard Seal (Order by Part No.)

Pg	Part Number		Cert.	Cable Range		Gland Dimensions				Pack
	Light Grey	Black		mm	Inches	TD	TL	H	ØD	
Pg7	180.007	180.107		3-6.5	0.118-0.256	12.5	8	25.3	17.0	100
Pg9	180.009	180.109		4-8	0.157-0.315	15.5	8	27.4	21.7	50
Pg11	180.011	180.111		5-10	0.197-0.394	18.6	8	32.2	25.0	50
Pg13.5	180.013	180.113		6-12	0.236-0.472	20.4	10	32.4	27.0	50
Pg16	180.016	180.116		10-14	0.394-0.551	22.5	10	31.9	30.9	50
Pg21	180.021	180.121		13-18	0.512-0.709	28.3	11	38.4	37.2	25
Pg29	180.029	180.129		18-25	0.709-0.984	37.0	11	43.3	47.1	20
Pg36	180.036	180.136		22-32	0.866-1.260	47.0	13	52.4	59.6	10
Pg42	180.042	180.142		30-38	1.181-1.496	54.0	13	54.8	67.8	10
Pg48	180.048	180.148		34-44	1.339-1.732	59.3	14	54.9	72.4	10



Information subject to change without notice - All dimensions in mm except where indicated
See page 36 for recommended cut-out sizes

Plastic Pg Glands with Reducing Seal (Order by Part No.)

Pg	Part Number		Cert.	Cable Range		Gland Dimensions				Pack
	Light Grey	Black		mm	Inches	TD	TL	H	ØD	
Pg7	181.007	181.107		2-5	0.079-0.197	12.5	8	25.3	17.0	100
Pg9	181.009	181.109		2-6	0.079-0.236	15.5	8	27.4	21.7	50
Pg11	181.011	181.111		3-7	0.118-0.276	18.6	8	32.2	25.0	50
Pg13.5	181.013	181.113		5-9	0.197-0.354	20.4	10	32.4	27.0	50
Pg16	181.016	181.116		7-12	0.276-0.472	22.5	10	31.9	30.9	50
Pg21	181.021	181.121		9-16	0.354-0.630	28.3	11	38.4	37.2	25
Pg29	181.029	181.129		12-20	0.472-0.787	37.0	11	43.3	47.1	20
Pg36	181.036	181.136		20-26	0.787-1.024	47.0	13	52.4	59.6	10
Pg42	181.042	181.142		25-31	0.984-1.220	54.0	13	54.8	67.8	10
Pg48	181.048	181.148		29-35	1.142-1.378	59.3	14	54.9	72.4	10

Information subject to change without notice - All dimensions in mm except where indicated
See page 36 for recommended cut-out sizes



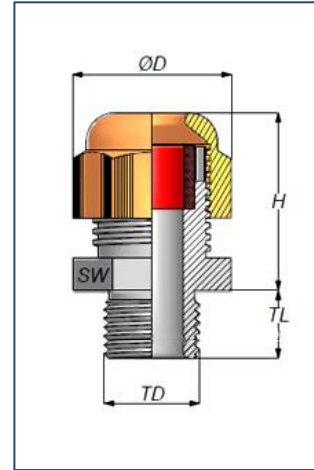
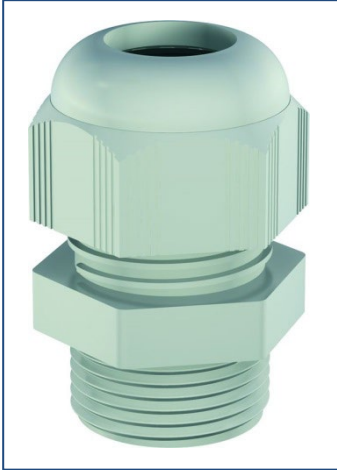

Plastic Glands with Long Thread - Metric & Pg

Features and specifications:

- Operating Temperature: -20 to 100°C (permanent), -30 to 150°C (intermittent)
- Ingress Protection: IP68 @ 5 bar
- Material: Body and dome: Polyamide 6, Seal: Chloroprene





Plastic Metric Glands with Long Thread (Order by Part No.)

M	Part No.		Cert.	Cable Range		Gland Dimensions				Pack
	Light Grey	Black		mm	Inches	TD	TL	H	ØD	
M12x1.5	-	180.112SL		2.5-6.5	0.098-0.256	12	15	32	17.0	50
M16x1.5	180.017L	180.117L		5-10	0.197-0.394	16	15	32.2	25.0	50
M20x1.5	180.020L	180.120L		6-12	0.236-0.472	20	15	32.4	27.0	50
M20x1.5	182.020L	182.120L		10-14	0.394-0.551	20	15	31.9	30.9	50
M25x1.5	180.025L	180.125L		13-18	0.512-0.709	25	15	38.4	37.2	25

Information subject to change without notice - All dimensions in mm except where indicated
See page 36 for recommended cut-out sizes

Plastic Pg Glands with Long Thread (Order by Part No.)

Pg	Part No.		Cert.	Cable Range		Gland Dimensions				Pack
	Light Grey	Black		mm	Inches	TD	TL	H	ØD	
Pg9	180.009L	180.109L		4-8	0.157-0.315	15.5	14.7	27.1	18.8	50
Pg11	180.011L	180.111L		5-10	0.197-0.394	18.6	14.9	32.0	22.0	50
Pg13.5	180.013L	180.113L		6-12	0.236-0.472	20.4	15.8	33.5	24.0	50

Information subject to change without notice - All dimensions in mm except where indicated
See page 36 for recommended cut-out sizes

Flex-Protect Spiral Plastic Glands

Flex-protect cable glands (also known as “spiral” glands) offer added protection to the cable at its point of entry. The spiral head distributes strain over a larger area, avoiding damage that can result through repeated bending of the cord. These glands are made of polyamide (plastic) and have an internal compression claw ring, which assures a liquid-tight and tug-proof grip on the cable.



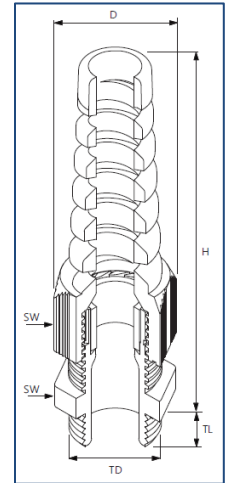

Available with standard and reducing seals.

Features and specifications:

- **Operating Temperature:** -20 to 100°C (permanent), -30 to 150°C (intermittent)
- **Ingress Protection:** IP68 @ 5 bar
- **Material:** Body and dome: Polyamide 6, Seal: Chloroprene







Flex-Protect NPT Plastic Glands with Standard Seal (Order by Part No.)

NPT	Part Number		Cert.	Cable Range		Gland Dimensions (mm)				Gland Dimensions (in)				Pack
	Light Grey	Black		mm	Inches	TD	TL	H	D	TD	TL	H	D	
3/8" NPT	180.538	180.438		5-10	.197-.394	17.1	15	83.2	25.1	0.671	.59	3.276	0.988	50
1/2" NPT	180.550	180.450		6-12	.236-.472	21.2	15	96.5	27.6	0.836	.59	3.799	1.086	50
1/2" NPT L	182.550	182.450		10-14	.394-.551	21.2	15	106.4	30.5	0.836	.59	4.109	1.201	50
3/4" NPT	182.575	182.475		14-18	.551-.709	26.6	15	118.9	37.9	1.046	.59	4.681	1.490	25





Information subject to change without notice - All dimensions in mm except where indicated. See page 36 for recommended cut-out sizes

Flex-Protect NPT Plastic Glands with Reducing Seal (Order by Part No.)

NPT	Part Number		Cert.	Cable Range		Gland Dimensions (mm)				Gland Dimensions (in)				Pack
	Light Grey	Black		mm	Inches	TD	TL	H	D	TD	TL	H	D	
3/8" NPT	181.538	181.438		3-7	.118-.276	17.1	15	83.2	25.1	0.671	.59	3.276	0.988	50
1/2" NPT	181.550	181.450		5-10	.197-.354	21.2	15	96.5	27.6	0.836	.59	3.799	1.086	50
1/2" NPT L	183.550L	183.450L		7-12	.276-.472	21.2	15	106.4	30.5	0.836	.59	4.109	1.201	50
3/4" NPT	183.575	183.475		9-16	.354-.630	26.6	15	118.9	37.9	1.046	.59	4.681	1.490	25





Information subject to change without notice - All dimensions in mm except where indicated. See page 36 for recommended cut-out sizes

Flex-Protect Metric Plastic Glands with Standard Seal (Order by Part No.)

M	Part Number		Cert.	Cable Range		Gland Dimensions				Pack
	Light Grey	Black		mm	Inches	TD	TL	H	D	
M12x1.5	180.512	180.412		3-6.5	0.118-0.256	12	8	58.0	16.6	100
M16x1.5	180.517	180.417		5-10	0.197-0.394	16	10	83.2	25.1	50
M20x1.5	180.520	180.420		6-12	0.236-0.472	20	10	96.5	27.6	50
M25x1.5	180.525	180.425		13-18	0.512-0.709	25	10	118.9	37.8	25







Information subject to change without notice - All dimensions in mm except where indicated. See page 36 for recommended cut-out sizes

Flex-Protect Metric Plastic Glands with Reducing Seal (Order by Part No.)

M	Part Number		Cert.	Cable Range		Gland Dimensions				Pack
	Light Grey	Black		mm	Inches	TD	TL	H	D	
M12x1.5	181.512	181.412		2-5	0.079-0.197	12	8	58.0	1.6	100
M16x1.5	181.517	181.417		3-7	0.118-0.276	16	10	83.2	25.1	50
M20x1.5	181.520	181.420		5-9	0.197-0.354	20	10	96.5	27.6	50
M25x1.5	181.525	181.425		9-16	0.354-0.630	25	10	118.9	37.8	25







Information subject to change without notice - All dimensions in mm except where indicated. See page 36 for recommended cut-out sizes

Flex-Protect Pg Plastic Glands with Standard Seal (Order by Part No.)

Pg	Part Number		Cert.	Cable Range		Gland Dimensions				Pack
	Light Grey	Black		mm	Inches	TD	TL	H	D	
Pg7	180.507	180.407		3-6.5	0.118-0.256	12.5	8	58.0	17.2	100
Pg9	180.509	180.409		4-8	0.157-0.315	15.5	8	68.4	21.5	50
Pg11	180.511	180.411		5-10	0.197-0.394	18.6	8	83.2	25.1	50
Pg13.5	180.513	180.413		6-12	0.236-0.472	20.4	10	96.5	27.6	50
Pg16	180.516	180.416		10-14	0.394-0.551	22.5	10	106.4	30.5	50
Pg21	180.521	180.421		13-18	0.512-0.709	28.3	11	118.9	37.8	25

Information subject to change without notice - All dimensions in mm except where indicated. See page 36 for recommended cut-out sizes

Flex-Protect Pg Plastic Glands with Reducing Seal (Order by Part No.)

Pg	Part Number		Cert.	Cable Range		Gland Dimensions				Pack
	Light Grey	Black		mm	Inches	TD	TL	H	D	
Pg7	181.507	181.407		2-5	0.079-0.197	12.5	8	58.0	17.2	100
Pg9	181.509	181.409		2-6	0.079-0.236	15.5	8	68.4	21.5	50
Pg11	181.511	181.411		3-7	0.118-0.276	18.6	8	83.2	25.1	50
Pg13.5	181.513	181.413		5-9	0.197-0.354	20.4	9	96.5	27.6	50
Pg16	181.516	181.416		7-12	0.276-0.472	22.5	10	106.4	30.5	50
Pg21	181.521	181.421		9-16	0.354-0.630	28.3	11	118.9	37.8	25

Information subject to change without notice - All dimensions in mm except where indicated. See page 36 for recommended cut-out sizes

Elbow Glands & Elbow Connectors

The elbow glands were designed for applications where the cable must enter the panel or machine parallel to its surface, in order to prevent sharp bending or to improve ingress protection against water, dust, etc. Elbow angle is 90 degrees. The elbow connectors unique 90 degrees connectors are provided with the same thread - one male, one female - at each end, thus permitting installation of a cable gland at right angle from the surface of the panel or machinery.

Features and specifications:

- **Operating Temperature:** Elbow glands: -20 to 100°C (permanent), Elbow connectors: -20 to 100°C (permanent)
- **Ingress Protection:** IP68 @ 5 bar
- **Gland Material:** Body and dome: Polyamide 6, **Seal:** Chloroprene, **O-ring:** Nitrile rubber
- **Connector Material:** Polyamide 6 + 30% fiberglass

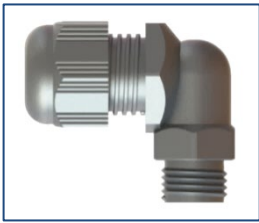

Plastic NPT Elbow Glands (Order by Part No.)

NPT	Part No.	Cable Range		Gland Dimensions (mm)			Gland Dimensions (in)			Pack
	Black	mm	Inches	TD	TL	H	TD	TL	H	
3/8" NPT	187.238	5-9	0.118-0.354	17.1	11.7	30.0	0.67	0.46	1.18	20
1/2" NPT	187.250	10-13	0.394-0.512	21.2	14.7	31.2	0.84	0.58	1.23	20
3/4" NPT	187.275	13-16	0.512-0.630	26.6	14.8	41.6	1.05	0.58	1.64	20
1 1/4" NPT	187.294	22-29	0.866-1.142	42.0	18.8	53.0	1.65	0.74	2.09	10

Information subject to change without notice. See page 36 for recommended cut-out sizes

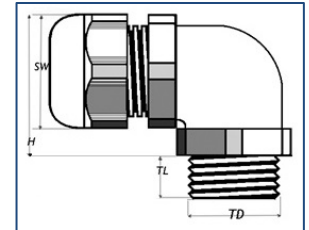

Plastic Pg Elbow Glands (Order by Part No.)

Pg	Part No.	Cable Range		Gland Dimensions (mm)			Gland Dimensions (in)			Pack
	Black	mm	Inches	TD	TL	H	TD	TL	H	
Pg 7	187.207	4-8	0.157-0.315	12.5	8	26.5	0.49	0.32	1.04	20
Pg 9	187.209	4-8	0.157-0.315	15.2	8	28.5	0.60	0.32	1.12	20

Information subject to change without notice. See page 36 for recommended cut-out sizes

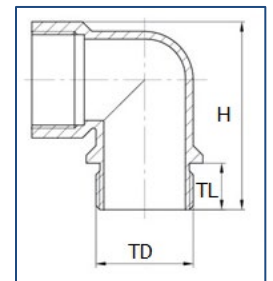

Plastic Metric Elbow Connectors (Order by Part No.)

M	Part No.	Connector Dimensions (mm)			Pack
	Grey	TD	TL	H	
M16x1.5	187.217	16	12	26.0	100
M20x1.5	187.220	20	12	30.0	50
M25x1.5	187.225	25	12	36.5	50
M32x1.5	187.232	32	14	43.5	25
M40x1.5	187.240	40	14	53.0	10

Information subject to change without notice. See page 36 for recommended cut-out sizes



Brass Glands - NPT Thread





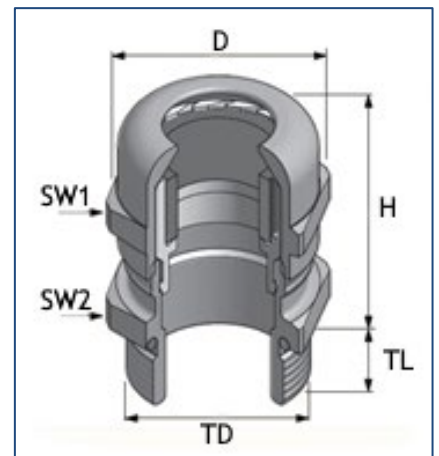

Liquid-tight brass glands offer excellent impact resistance, resistance to most chemicals and solvents, a wide temperature range, while maintaining a liquid-tight and tug-proof grip on the cable by means of the inner claw ring. They accept a wide range of cable diameters.

Features and specifications:

- **Operating Temperature:** -20 to 100°C (permanent), -40 to 150°C (intermittent)
- **Ingress Protection:** IP68 @ 5 bar for 30 minutes
- **Material:** Body and dome: Brass, nickel plated, **Claw ring:** Polyamide 6, **Sealing ring:** Chloroprene, **O-ring:** NBR







Brass NPT Glands with Regular Seal (Order by Part No.)

NPT	Part No.	Cert.	Cable Range		Gland Dimensions (mm)				Gland Dimensions (in)				Pack
			mm	inches	TD	TL	H	ØD	TD	TL	H	ØD	
3/8" NPT	180.738	C 	4-8	.157-.314	17.1	11.5	25.5	21.0	.671	.453	1.004	.826	50
1/2" NPT	180.750	C 	6-12	.236-.472	21.2	13.0	27.5	24.5	.836	.511	1.004	1.083	50
1/2" NPT	182.750*	c 	10-14	.394-.551	21.2	13.0	30.0	26.8	.836	.511	1.181	1.055	50
3/4" NPT	180.775	c 	13-18	.511-.708	26.6	13.0	38.0	33.0	1.05	.511	1.496	1.299	25
1" NPT	180.791	c 	18-25	.708-.984	33.2	13.0	45.5	48.5	1.31	.511	1.792	1.909	20
1 1/4" NPT	180.794	c 	22-32	.866-1.26	42.0	25.6	50.0	55.5	1.65	1.01	1.97	2.19	5
1 1/2" NPT	180.796	c 	30-38	1.18-1.50	48.1	26.0	51.0	64.0	1.89	1.02	2.01	2.52	1
2" NPT	180.798	—	34-44	1.34-1.73	60.1	27.0	55.0	70.0	2.37	1.06	2.17	2.76	1

Information subject to change without notice. See page 36 for recommended cut-out sizes

* Special order

Brass NPT Glands with Reducing Seal (Order by Part No.)

NPT	Part No.	Cert.	Cable Range		Gland Dimensions (mm)				Gland Dimensions (in)				Pack
			mm	inches	TD	TL	H	ØD	TD	TL	H	ØD	
3/8" NPT	181.738	C 	3-7	.118-.276	17.1	11.5	31.5	22.0	.671	.452	1.240	.866	50
1/2" NPT	181.750	c 	5-9	.197-.354	21.2	13.0	25.5	24.5	.836	.511	1.003	.965	50
3/4" NPT	181.775	c 	9-16	.354-.630	26.6	13.0	38.0	33.0	1.05	.511	1.397	1.299	25
1" NPT	181.791	c 	7-17	.276-.669	33.2	25.0	30.0	36.0	1.31	.984	1.181	1.417	20

Information subject to change without notice. See page 36 for recommended cut-out sizes



Brass Glands - Metric

Features and specifications:

- Operating Temperature: -20 to 100°C (permanent), -40 to 150°C (intermittent, silicone seal)
- Ingress Protection: IP68 @ 5 bar
- Material: Body and dome: Brass, nickel plated, Claw ring: Polyamide 6, Seal: Chloroprene

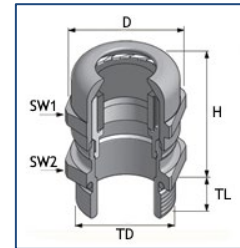

Brass Metric Glands with Standard & Long Thread (Order by Part No.)

M	Part No.	Cert.	Cable Range		Gland Dimensions					Pack
			mm	Inches	TD	TL	H	SW1	SW2	
M12x1.5	180.712	C ^{UL} US	3-6.5	0.118-0.256	12	6	24.0	14	14	50
M12x1.5	180.712L	C ^{UL} US	3-6.5	0.118-0.256	12	12	24.0	14	14	50
M16x1.5	180.717	C ^{UL} US	4-8	0.157-0.315	16	7	25.5	17	18	50
M16x1.5	180.717L	C ^{UL} US	4-8	0.157-0.315	16	12	25.5	17	18	50
M20x1.5	180.720	C ^{UL} US	6-12	0.236-0.472	20	8	26.0	22	22	50
M20x1.5	180.720L	C ^{UL} US	6-12	0.236-0.472	20	12	26.5	22	22	50
M25x1.5	180.725	C ^{UL} US	10-14	0.394-0.551	25	8	30.0	24	27	25
M25x1.5	180.725L	C ^{UL} US	10-14	0.394-0.551	25	12	30.0	24	27	25
M32x1.5	180.732	C ^{UL} US	13-18	0.512-0.709	32	9	35.0	30	34	20
M32x1.5	180.732L	C ^{UL} US	13-18	0.512-0.709	32	15	35.0	30	34	25
M40x1.5	180.740	C ^{UL} US	18-25	0.709-0.984	40	9	40.5	40	43	20
M40x1.5	180.740L	C ^{UL} US	18-25	0.709-0.984	40	15	40.5	40	43	20
M50x1.5	180.751	C ^{UL} US	22-32	0.866-1.26	50	9	50.0	50	55	15
M50x1.5	180.751L*	C ^{UL} US	22-32	0.866-1.260	50	15	50.3	50	55	15
M63x1.5	180.763	C ^{UL} US	34-44	1.339-1.732	63	14	55.0	64	68	12
M63x1.5	180.763L*	C ^{UL} US	34-44	1.339-1.732	63	18	55.0	64	68	12
M72x2	180.772	—	56-62	2.204-2.441	72	16	57.0	77	77	4
M75x1.5	180.776	—	48-65	1.89-2.56	75	11.5	81.8	85	85	1
M75x1.5	180.776L	—	48-65	1.89-2.56	75	18	82	85	90	1
M80x2	180.780	—	55-74	2.17-2.91	80	12	92	95	100	1
M80x2	180.780L	—	55-74	2.17-2.91	80	20	92	95	100	1
M85x2	180.785S	—	68-77	2.68-3.03	85	22	54	95	95	1
M85x2	180.785L	—	68-77	2.68-3.03	85	22	54	95	95	1
M90x2	180.790	—	65-83	2.56-3.27	90	12	101	125	135	1
M90x2	180.790L	—	65-83	2.56-3.27	90	22	101	110	135	1
M100x2	180.800	—	74-93	2.91-3.50	100	12	101	125	135	1
M100x2	180.800L	—	74-93	2.91-3.50	100	22	101	120	125	1
M110x2	180.810	—	74-93	2.91-3.50	110	12	101	125	135	1

Information subject to change without notice - All dimensions in mm except where indicated.
See page 36 for recommended cut-out sizes







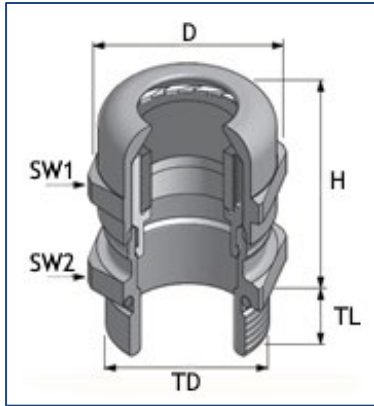













Brass Glands - Pg

Features and specifications:

- Operating Temperature: -20 to 100°C (permanent), -40 to 150°C (intermittent, silicone seal)
- Ingress Protection: IP68 @ 5 bar
- Material: Body and dome: Brass, nickel plated, Claw ring: Polyamide 6, Seal: Chloroprene



Brass Pg Glands with Standard and Long Thread (Order by Part No.)

Pg	Part No.	Cert.	Cable Range		Gland Dimensions					Pack
			mm	inches	TD	TL	H	SW1	SW2	
Pg7	180.707	C 	3-6.5	0.118-0.256	12.5	6.0	24.0	14	14	50
Pg7	180.707L*	C 	3-6.5	0.118-0.256	12.5	10	24.0	14	14	50
Pg9	180.709	C 	4-8	0.157-0.315	15.5	6.0	25.5	17	17	50
Pg9	180.709L*	C 	4-8	0.157-0.315	15.5	10	25.5	17	17	50
Pg11	180.711	C 	5-10	0.197-0.394	18.6	6.0	28.0	20	20	50
Pg11	180.711L*	C 	5-10	0.197-0.394	18.6	10	28.0	20	20	50
Pg13.5	180.713	C 	6-12	0.236-0.472	20.4	6.5	26.5	22	22	50
Pg13.5	180.713L*	C 	6-12	0.236-0.472	20.4	10	26.5	22	22	50
Pg16	180.716	C 	10-14	0.394-0.551	22.5	6.5	30.0	24	24	25
Pg16	180.716L*	C 	10-14	0.394-0.551	22.5	10	30.0	24	24	25
Pg21	180.721	C 	13-18	0.512-0.709	28.3	7.2	35.0	30	30	25
Pg21	180.721L*	C 	13-18	0.512-0.709	28.3	12	35.0	30	30	25
Pg29	180.729	C 	18-25	0.709-0.984	37.0	8.0	40.5	40	40	20
Pg29	180.729L	C 	18-25	0.709-0.984	37.0	12	40.5	40	40	25
Pg36	180.736	C 	22-32	0.866-1.260	47.0	9.0	48.0	50	50	15
Pg36	180.736L	C 	22-32	0.866-1.259	47.0	14	50.0	50	50	25
Pg42	180.742	C 	30-38	1.181-1.496	54.0	12.0	50.5	51	50	12
Pg42	180.742L*	C 	30-38	1.18-1.496	54.0	16	48.5	51	58	10
Pg48	180.748	C 	34-44	1.339-1.732	59.3	14.0	54.5	64	64	12
Pg48	180.748L*	C 	34-44	1.34-1.732	59.3	18	54.5	64	64	10

Information subject to change without notice - All dimensions in mm except where indicated.

See page 36 for recommended cut-out sizes

* Special order



Brass Glands with Reducing Seals - Metric & Pg

Features and specifications:

- **Operating Temperature:** -20 to 100°C (permanent), -40 to 150°C (intermittent, silicone seal)
- **Ingress Protection:** IP68 @ 5 bar
- **Material:** Body and dome: Brass, nickel plated, Claw ring: Polyamide 6, Seal: Chloroprene

Brass Metric Glands with Reducing Seal (Order by Part No.)

M	Part No.	Cert.	Cable Range		Gland Dimensions					Pack
			mm	Inches	TD	TL	H	SW1	SW2	
M12x1.5	181.712		2-5	0.079-0.197	12	6	24.0	14	14	50
M16x1.5	181.717		3-7	0.118-0.276	16	7	30.5	20	20	50
M20x1.5	181.720		5-9	0.197-0.354	20	8	28.0	22	22	50
M25x1.5	181.725		7-12	0.276-0.472	25	8	30.0	24	27	25
M32x1.5	181.732		9-16	0.354-0.630	32	9	35.0	30	34	20
M40x1.5	181.740		12-20	0.472-0.787	40	9	40.5	40	43	20
M50x1.5	181.751*	—	20-26	0.787-1.024	50	9	50.0	50	55	15
M63x1.5	181.763*	—	29-35	1.142-1.380	63	14	55.0	64	68	12

Information subject to change without notice - All dimensions in mm except where indicated

* Special order. See page 36 for recommended cut-out sizes

Brass Pg Glands with Reducing Seal (Order by Part No.)

Pg	Part No.	Cert.	Cable Range		Gland Dimensions					Pack
			mm	inches	TD	TL	H	SW1	SW2	
Pg7	181.707		2-5	0.079-0.197	12.5	6.0	24.0	14	14	50
Pg9	181.709		2-6	0.079-0.236	15.5	6.0	25.5	17	17	50
Pg11	181.711		3-7	0.118-0.276	18.6	6.0	28.0	20	20	50
Pg13.5	181.713		5-9	0.197-0.354	20.4	6.5	26.5	22	22	50
Pg16	181.716		7-12	0.276-0.472	22.5	6.5	30.0	24	24	25
Pg21	181.721		9-16	0.354-0.630	28.3	7.2	35.0	30	30	25
Pg29	181.729		12-20	0.472-0.787	37.0	8.0	38.5	40	40	20
Pg36	181.736		20-26	0.787-1.024	47.0	9.0	40.5	50	50	15
Pg42	181.742*		25-31	0.984-1.220	54.0	12.0	51.0	58	58	12
Pg48	181.748*		29-35	1.14-1.378	59.3	14.0	54.5	64	64	12

* Special order. Information subject to change without notice - All dimensions in mm except where indicated.

See page 36 for recommended cut-out sizes

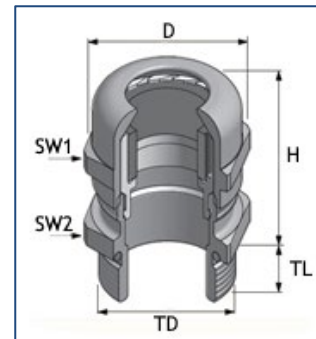

Large Head Brass Glands - Metric

Features and specifications:

- Operating Temperature: -20 to 100°C (permanent), -40 to 150°C (intermittent, silicone seal)
- Ingress Protection: IP68 @ 5 bar
- Material: Body and dome: Brass, nickel plated, Claw ring: Polyamide 6, Seal: Chloroprene

Large Head Brass Glands with Regular Thread - Metric (Order by Part No.)

M	Part No.	Cert.	Cable Range		Gland Dimensions					Pack
			mm	inches	TD	TL	H	SW1	SW2	
M12x1.5	182.712	—	3-6.5	0.118-0.256	12	6	24	14	14	50
M16x1.5	182.717	—	5-10	0.197-0.394	16	6.5	31.5	20	20	50
M20x1.5	182.720	—	10-14	0.394-0.551	20	8	30	24	24	50
M25x1.5	182.725	cUL US	13-18	0.512-0.709	25	8	35	30	30	25
M32x1.5	182.732	cUL US	18-25	0.709-0.984	32	9	46	40	40	25
M40x1.5	182.740	cUL US	22-32	0.866-1.260	40	9	50	50	55.5	20
M50x1.5	182.751	cUL US	34-44	1.339-1.732	64	9	55	64	64	15

Information subject to change without notice - All dimensions in mm except where indicated
See page 36 for recommended cut-out sizes

Brass Large Head Metric Glands with Long Thread (Order by Part No.)

M	Part No.	Cert.	Cable Range		Gland Dimensions					Pack
			mm	inches	TD	TL	H	SW1	SW2	
M12x1.5	182.712L	cUL US	3-6.5	0.118-0.256	12	6	24	14	14	50
M16x1.5	182.717L	cUL US	5-10	0.197-0.394	16	12	31.5	20	20	50
M20x1.5	182.720L	cUL US	10-14	0.394-0.551	20	12	30.0	24	24	50
M25x1.5	182.725L	cUL US	13-18	0.512-0.709	25	12	35.5	30	30	25
M32x1.5	182.732L	cUL US	18-25	0.709-0.984	32	15	46.0	40	40	25
M40x1.5	182.740L	cUL US	22-32	0.866-1.260	40	15	54.5	50	50	20
M50x1.5	182.751L*	cUL US	34-44	1.339-1.732	50	15	55.0	64	68	15
M63x1.5	182.763L*	cUL US	37-53	1.457-2.087	63	18	53.0	75	75	12

Information subject to change without notice - All dimensions in mm except where indicated
See page 36 for recommended cut-out sizes

* Special order

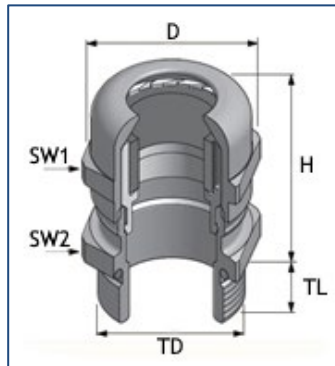

Stainless Steel Glands

Stainless Steel glands offer high mechanical qualities, excellent resistance to most chemicals and aggressive environments. Applications include food, pharmaceutical, petrochemical industries, marine use, corrosive environments.

Features and Specifications:

- **Operating temperature:** -20 to 100°C (permanent), -40 to 150°C (intermittent)
- **Ingress Protection:** IP68 @ 5Bar for 30 minutes
- **Material:** Body and dome: Stainless Steel 1.4305 (AISI 303)
 Claw ring: Polyamide 6
 Seal: Chloroprene
 O-ring: NBR

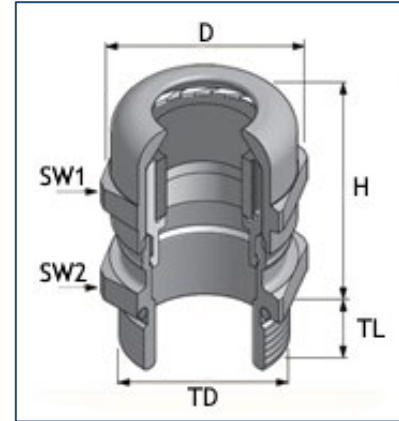

Stainless Steel Metric Glands (Order by Part No.)

M	Part No.	Cert.	Cable Range		Gland Dimensions					Pack
			mm	Inches	TD	TL	H	SW1	SW2	
M12x1.5	180.612	UL US	3-6.5	0.118-0.256	12	6	24.0	14	14	50
M16x1.5	180.617	UL US	4-8	0.157-0.315	16	7	25.5	17	18	50
M20x1.5	180.620	UL US	6-12	0.236-0.472	20	8	26.5	22	22	50
M25x1.5	180.625	UL US	10-14	0.394-0.551	25	8	30.0	24	27	25
M32x1.5	180.632	UL US	13-18	0.512-0.709	32	9	35.0	30	36	20
M40x1.5	180.640	UL US	18-25	0.709-0.984	40	9	40.5	41	46	20
M50x1.5	180.651*	UL US	22-32	0.866-1.26	50	9	50.0	50	55	15
M63x1.5	180.663*	UL US	34-44	1.339-1.732	63	14	55.0	65	70	12

Information subject to change without notice - All dimensions in mm except where indicated.

* Special order

See page 36 for recommended cut-out sizes

Stainless Steel NPT Glands with Regular Seal (Order by Part No.) -

NPT	Part No.	Cert.	Cable Range		Gland Dimensions (mm)				Gland Dimensions (in)				Pack
			mm	inches	TD	TL	H	ØD	TD	TL	H	ØD	
3/8" NPT	180.638	UL US	4-8	.157-.314	17.1	11.5	25.5	21	.671	.452	0.905	.866	50
1/2" NPT	180.650	UL US	6-12	.236-.472	21.2	13.0	31	30	.836	.511	1.003	.964	50
3/4" NPT	180.675	UL US	13-18	.511-.708	26.6	13.0	38	33	1.05	.511	1.397	1.299	25
1" NPT	180.691	—	18-25	.708-.984	33.2	13.0	45.5	45.5	1.31	.511	1.692	1.751	10
1 1/4" NPT	180.694*	—	22-32	.866-1.26	42.0	25.6	51.0	55.5	1.65	1.01	1.97	2.19	5
1 1/2" NPT	180.696*	—	30-38	1.18-1.50	48.1	26.0	50.0	66.5	1.89	1.02	2.01	2.52	5

Information subject to change without notice. See page 36 for recommended cut-out sizes

* Special order

Metric models and selected NPT models available in versions with: Reducing seal, Large Head, Long thread

Available in 304L and 316L Stainless steel.

Stainless Steel Metric Glands with Reducing Seal (Order by Part No.)

M	Part No.	Cert.	Cable Range		Gland Dimensions					Pack
			mm	Inches	TD	TL	H	SW1	SW2	
M12x1.5	181.612	—	2-5	0.079-0.197	12	6	24.0	14	14	50
M16x1.5	181.617	—	3-7	0.118-0.276	16	7	30.5	22	22	50
M20x1.5	181.620	—	5-9	0.197-0.354	20	8	26.5	22	22	50
M25x1.5	181.625	—	7-12	0.276-0.472	25	8	30.0	24	27	25
M32x1.5	181.632	—	9-16	0.354-0.630	32	9	35.0	30	36	20
M40x1.5	181.640	—	12-20	0.472-0.787	40	9	40.5	41	46	20
M50x1.5	181.651*	—	20-26	0.787-1.024	50	9	50.0	50	55	15
M63x1.5	181.663*	—	29-35	1.142-1.380	63	14	55.0	65	70	12

Information subject to change without notice - All dimensions in mm except where indicated

* Special order. See page 36 for recommended cut-out sizes

Stainless Steel NPT Glands with Reducing Seal (Order by Part No.)

NPT	Part No.	Cert.	Cable Range		Gland Dimensions (mm)				Gland Dimensions (in)				Pack
			mm	inches	TD	TL	H	ØD	TD	TL	H	ØD	
3/8" NPT	181.638	—	3-7	.118-.276	17.1	11.5	31.5	24	.671	.452	0.905	.866	50
1/2" NPT	181.650	—	5-9	.197-.354	21.2	13.0	25.5	22	.836	.512	1.003	.964	50
3/4" NPT	181.675	—	9-16	.354-.630	26.6	13.0	35.5	33	1.05	.512	1.397	1.299	25
1" NPT	181.691	—	12-20	.472-.787	33.2	13.0	45.5	45.5	1.31	.512	1.791	1.791	10

Information subject to change without notice. See page 36 for recommended cut-out sizes

Stainless Steel Metric Glands - Large Head (Order by Part No.)

M	Part No.	Cert.	Cable Range		Gland Dimensions					Pack
			mm	inches	TD	TL	H	SW1	SW2	
M16x1.5	182.617	cUL _{US}	5-10	0.197-0.394	16	7.0	30.5	22	22	50
M16x1.5	182.617L	—	5-10	0.197-0.394	16	12.0	30.5	22	22	50
M20x1.5	182.620	cUL _{US}	10-14	0.394-0.551	20	8	28.0	24	24	50
M20x1.5	182.620L	—	10-14	0.394-0.551	20	12	28.0	24	24	50
M25x1.5	182.625	cUL _{US}	13-18	0.512-0.709	25	8	35.0	30	30	50
M25x1.5	182.625L	—	13-18	0.512-0.709	25	12	35.0	30	30	50
M32x1.5	182.632	cUL _{US}	18-25	0.709-0.984	32	9	39.5	41	41	50
M32x1.5	182.632L	—	18-25	0.709-0.984	32	15	39.5	41	41	50
M40x1.5	182.640	cUL _{US}	22-32	0.866-1.260	40	9	51.0	50	50	25
M40x1.5	182.640L	—	22-32	0.866-1.260	40	15	51.0	50	50	25
M50x1.5	182.651*	cUL _{US}	34-44	1.063-1.732	50	9	55.0	65	65	20
M50x1.5	182.651L*	—	34-44	1.063-1.732	50	15	55.0	65	65	20
M63x1.5	182.663*	cUL _{US}	37-53	1.457-2.087	63	10	53.0	75	75	10
M63x1.5	182.663L*	—	37-53	1.457-2.087	63	18	53.0	75	75	10

Information subject to change without notice - All dimensions in mm except where indicated

* Special order. See page 36 for recommended cut-out sizes

EMC Brass Glands



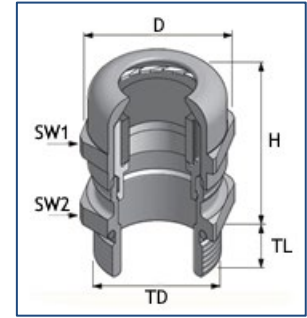

The EMC cable glands (Series 2) combine several advantages in one product.

Features and specifications:

- The same clamping ranges as the standard brass glands
- The cable gland does not have to be disassembled; a perfect shielding will be achieved by just tightening the dome nut. The components are pre-assembled
- **Operating Temperature:** -20 to 100°C (permanent), -40 to 150°C (intermittent)
- **Ingress protection:** IP68 @ 5 bar
- **Material:** Body and dome: Brass, nickel plated, **Contact elements:** Copper alloy, **Seal:** Chloroprene, **O-ring:** Nitrile Rubber











Brass NPT EMC Glands with Regular Seal (Order by Part No.)

NPT	Part No.	Cert.	Cable Range		Gland Dimensions (mm)				Gland Dimensions (in)				Pack
			mm	Inches	TD	TL	H	D	TD	TL	H	D	
3/8" NPT	180.938		5-10	0.196-0.394	17.1	11.5	31.5	22.0	0.671	0.452	1.240	0.866	50
1/2" NPT	180.950		6-12	0.236-0.472	21.2	13.0	27.5	24.5	0.836	0.511	1.082	0.965	50
3/4" NPT	180.975		13-18	0.511-0.709	26.6	13.0	38.0	33.0	1.05	0.511	1.496	1.299	25
1" NPT	180.991		18-25	0.708-0.984	33.2	13.0	45.5	48.5	1.31	0.511	1.791	1.909	10

Information subject to change without notice - Dimensions in mm except where indicated. See page 36 for recommended cut-out sizes











Brass Metric EMC Glands with Regular Seal (Order by Part No.)

M	Part No.	Cert.	Cable Range		Gland Dimensions					Pack
			mm	Inches	TD	TL	H	SW1	SW2	
M12x1.5	180.912		3-6.5	0.118-0.256	12	6	24.0	14	14	50
M16x1.5	180.917		4-8	0.157-0.315	16	7	25.5	17	18	50
M20x1.5	180.920		6-12	0.236-0.472	20	8	26.5	22	22	50
M25x1.5	180.925		10-14	0.394-0.551	25	8	30.0	24	27	25
M32x1.5	180.932		13-18	0.512-0.709	32	9	35.0	30	34	25
M40x1.5	180.940		18-25	0.709-0.984	40	9	40.5	40	43	20
M50x1.5	180.951		22-32	0.866-1.260	50	9	50.0	50	55	15
M63x1.5	180.963		34-44	1.339-1.732	63	14	55.0	64	68	12



Large head metric EMC domed glands up to M110x2 are available on request. Information subject to change without notice - Dimensions in mm except where indicated. See page 36 for recommended cut-out sizes

Brass Pg EMC Glands with Regular Seal (Order by Part No.)

Pg	Part No.	Cert.	Cable Range		Gland Dimensions					Pack
			mm	inches	TD	TL	H	SW1	SW2	
Pg7	180.907		3-6.5	0.118-0.256	12.5	6.0	24.0	14	14	50
Pg9	180.909		4-8	0.157-0.315	15.5	6.0	25.5	17	17	50
Pg11	180.911		5-10	0.197-0.394	18.6	6.0	28.0	20	20	50
Pg13.5	180.913		6-12	0.236-0.472	20.4	6.5	26.5	22	22	50
Pg16	180.916		10-14	0.394-.0551	22.5	6.5	30.0	24	24	25
Pg21	180.921		13-18	0.512-.0709	28.3	7.2	35.0	30	30	25
Pg29	180.929		18-25	0.709-0.984	37.0	8.0	40.5	40	40	20
Pg36	180.936		22-32	0.866-1.260	47.0	9.0	50.0	50	50	15
Pg42	180.942		30-38	1.18-1.496	54.0	12.0	51.0	58	58	12
Pg48	180.948		34-44	1.339-1.73	59.3	14.0	55.0	64	64	12

Information subject to change without notice - Dimensions in mm except where indicated. See page 36 for recommended cut-out sizes

Ventilation Glands



Ventilation glands provide the advantages of cable glands and pressure balance elements combined in one product. Properties of the membrane stay the same independent of the cable diameter and torque.



Features and specifications:





- **Operating Temperature:** -20 to 100°C (permanent), -30 to 150°C (intermittent)
- **Ingress Protection:** IP66/67
- **Material:** Body (metal): Brass, nickel plated, Body (Plastic): Polyamide 6, Clamping Insert (metal only): Polyamide 6 light grey, Membrane: PTFE, Seal: Chloroprene, Washer: NBR

Plastic Ventilation Glands (Order by Part No.)

M	Light Grey	Cert.	Model	Cable Range		Dimensions					Permeability*		
	Black.			mm	inches	TD	TL	H	D	SW	AAP	WIP	WID
	Part No.												
M12x1.5	180.012V	c 	BMVG-1S	4-7	0.157-0.276	12.0	8.0	28.3	21.7	19	25	0.1	1.0
	180.112V												
M16x1.5	180.016V	c 	BMVG-11	4-7	0.157-0.276	16.0	10.0	28.3	21.7	19	25	0.1	1.0
	180.116V												
M20x1.5	180.020V	c 	BMVG-12	6-11	0.236-0.433	20.0	10.0	33.3	27.0	24	40	0.1	1.0
	180.120V												

* AAP - Average Air Permeability in lt/hour, WIP - Water Intrusion Pressure in mbar, WID - Water Immersion Depth in meters
 Information subject to change without notice - All dimensions in mm except where indicated
 All ventilation glands come in packages of 50 See page 36 for recommended cut-out sizes

Brass Ventilation Glands (Order by Part No.)

M	Part No.	Cert.	Model	Cable Range		Dimensions					Permeability*		
				mm	Inches	TD	TL	H	D	SW	AAP	WIP	WID
M12x1.5	180.712V	c 	BMBCVG-0S	4-7	0.157-0.276	12.0	8.0	32.5	18.9	17	25	0.1	1.0
M16x1.5	180.716V	c 	BMBCVG-01	4-7	0.157-0.276	16.0	8.0	29.0	18.9	17	25	0.1	1.0
M16x1.5	180.716VL	c 	BMBCVG-01L	5-9	0.197-0.354	16.0	8.0	36.0	22.0	20	35	0.1	1.0
M20x1.5	180.720V	c 	BMBCVG-02	6-11	0.236-0.433	20.0	8.0	32.5	24.5	22	50	0.1	1.0

* AAP - Average Air Permeability in lt/hour, WIP - Water Intrusion Pressure in mbar, WID - Water Immersion Depth in meters
 Information subject to change without notice - All dimensions in mm except where indicated
 All ventilation glands come in packages of 50 See page 36 for recommended cut-out sizes

Ventilation Plugs

Ventilation plugs (also known as pressure balance elements) are membrane devices which are permeable to air, gases and vapour, and impermeable, or almost impermeable to water, liquids, and dust. The degree of permeability to liquids depends upon the size of the pores and structure of the membrane inside such devices.



Applications include:

- prevention of pressure increase inside an enclosure without risk of penetration of liquids
- prevention of accidental suction of liquids in an enclosure when its inside temperature decreases
- allowing air flow for ventilation
- improved maintenance criteria, since pressure buildup will not be present if the interior of an enclosure is hot, etc...

The products presented here include a range of IP67 metallic and non-metallic plugs, equipped with an acrylic co-polymer membrane on a plastic support, with different degrees of permeability (Standard, Medium, High, Ultra-High). The higher the degree of permeability, the lower the pressure at which liquid intrusion occurs. Models include standard and high permeability plastic and stainless steel.

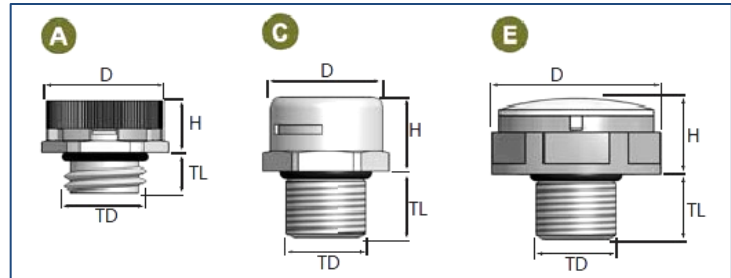





Consult ITC for models with Ultra-high permeability, and models not listed.

Features and specifications:









- **Operating Temperature:** -20 to 100°C (permanent), -30 to 150°C (intermittent)
- **Ingress Protection:** IP68/67 (for the water intrusion 0.1 bar)
- **Material:**
 - **Body (SS models):** Stainless Steel, **Body (plastic models):** Polyamide 6 V2, light grey
 - **O-ring:** Nitrile rubber, **Membrane:** Acrylic co-polymer on plastic support

Plastic Metric Ventilation Plugs (Order by Part No.)

M					Dimensions					Permeability*		dwg
	P *	Part No.	Cert.	Model	TD	TL	H	D	SW	AAP	WIP	
M12x1.5	Std.	195.012S		SBVPB-11	12.0	6.0	7.6	18.5	17	16	0.9	A
M12x1.5 long thread	Std.	195.012S-L		SBVPB-11L	12.0	10.0	7.6	18.5	17	16	0.9	A
M12x1.5 long thread	Med	195.012M-L		MBVPB-11L	12.0	10.0	7.6	18.5	17	25	0.5	A
M12x1.5 long thread	High	195.012H-L		HBVPB-11L	12.0	10.0	7.6	18.5	17	120	0.2	A
M16x1.5	High	195.016H	—	HBVPF-11	16.0	10.0	11.7	26.0	24	450	0.2	E
M20x1.5	Std.	195.020S	—	SBVPE-11	20.0	10.0	11.7	26.0	24	42	0.9	E
M20x1.5	High	195.020H	—	HBVPE-11	20.0	10.0	11.7	26.0	24	450	0.2	E

* P=Degree of permeability - AAP - Average Air Permeability in lt/hour, WIP - Water Intrusion Pressure in mbar
 Information subject to change without notice - All dimensions in mm except where indicated
 See page 36 for recommended cut-out sizes
 All ventilation plugs come in packages of 50

Stainless Steel Metric Ventilation Plugs (Order by Part No.)

M/Pg					Dimensions					Permeability*		dwg
	P *	Part No.	Cert.	Model	TD	TL	H	D	SW	AAP	WIP	
M12x1.5	Std.	195.712S		SBBVP-01L	12.0	10.0	11.0	18.8	17	16	0.9	C
M12x1.5	High	195.712H		HBBVP-01L	12.0	10.0	11.0	18.8	17	120	0.2	C
Pg7	Std.	195.707S		SBBVP-0S	12.5	10.5	11.0	18.8	17	42	0.9	E
Pg7	High	195.707H		HBBVP-0S	12.5	10.5	11.0	18.8	17	42	0.9	E
M16x1.5	Std.	195.716S		SBBVP-02	16.0	6.0	12.0	20.0	18	120	0.2	C
M16x1.5	High	195.716H		HBBVP-02	16.0	6.0	12.0	20.0	18	16	0.9	C
M20x1.5	Std.	195.720S		SBBVP-03L	20.0	6.0	13.0	24.5	22	16	0.9	C
M20x1.5	High	195.720H		HBBVP-03L	20.0	6.0	13.0	24.5	22	120	0.2	C

* P=Degree of permeability - AAP - Average Air Permeability in lt/hour, WIP - Water Intrusion Pressure in mbar
 Information subject to change without notice - All dimensions in mm except where indicated
 See page 36 for recommended cut-out sizes
 All ventilation plugs come in packages of 50

Accessories - Plastic Locknuts with Flange

Flanged plastic locknuts offer the advantage of a larger contact surface: this in turn means better seal, correction of possible irregularities of the cutout. Sealing quality can be improved by means of an additional sealing washer, mounted between the gland and the panel.

Available in NPT, Metric and Pg thread. PF (Gas, or ISO) thread upon request.

Features and specifications:

- **Operating Temperature:** -20 to 100°C (permanent), -30 to 150°C (intermittent)
- **Standard colours:** black (similar to RAL9005) and light grey (similar to RAL7035)
- **Other colours:** dark grey (similar to RAL7001), red ◊ (similar to RAL3020), blue ◊ (similar to RAL5015), white ◊ (similar to RAL9003); upon request only; (◊ = metric only)
- **Material:** Polyamide 6 with 30% fiberglass

Plastic Metric Locknuts with Flange (Order by Part No.)

M	Part No.		Dimensions			Pack
	Light Grey	Black	SW	H	SW	
M12x1.5	184.012	184.112	18	5	19.5	100
M16x1.5	184.017	184.117	22	5	24.2	50
M20x1.5	184.020	184.120	26	6	28.6	50
M25x1.5	184.025	184.125	32	6	35.0	50
M32x1.5	184.032	184.132	41	7	46.1	25
M40x1.5	184.040	184.140	50	7	55.3	10
M50x1.5	184.051	184.151	60	8	66.1	10
M63x1.5	184.063	184.163	75	8	82.5	10
M75x2	—	184.174	85	15	94	5

Information subject to change without notice - Dimensions in mm except where indicated



Plastic Pg Locknuts with Flange (Order by Part No.)

Pg	Part No.		Dimensions			Pack
	Light Grey	Black	SW	H	ØD	
Pg7	184.007	184.107	19	5	21	50
Pg9	184.009	184.109	22	5	24	50
Pg11	184.011	184.111	24	5	26	50
Pg13.5	184.013	184.113	27	6	29	50
Pg16	184.016	184.116	30	6	33	50
Pg21	184.021	184.121	36	7	39	25
Pg29	184.029	184.129	46	7	50	20
Pg36	184.036	184.136	60	8	66	10
Pg42	184.042	184.142	65	8	73	10
Pg48	184.048	184.148	70	8	78	10

Information subject to change without notice - Dimensions in mm except where indicated

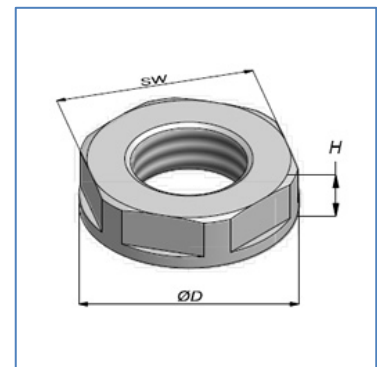

Plastic NPT Locknuts with Flange (Order by Part No.)

NPT	Part Number		Dimensions (mm)			Dimensions (in)			Pack
	Light Grey	Black	SW	H	ØD	SW	H	ØD	
3/8" NPT	184.038	184.138	22	5	25.0	.866	.276	0.984	50
1/2" NPT	184.050	184.150	27	5	30.5	1.063	.276	1.200	50
3/4" NPT	184.075	184.175	33	5	37.5	1.299	.276	1.476	25
1" NPT	184.091	184.191	47	6	46.5	1.85	.276	1.831	20
1 1/4" NPT	184.094	184.194	48.8	9	54.0	1.92	.354	2.126	10



Information subject to change without notice - Dimensions in mm except where indicated

Accessories - Plastic Locknuts without Flange

Non-flanged plastic locknuts (Metric and Pg thread) are mostly used when there is limited space for the application of the locknut. Sealing quality can be improved by means of an additional sealing washer, mounted between the gland and the panel.

Features and specifications:

- **Operating Temperature:** -20 to 80°C (permanent)
- **Colours:** Black (similar to RAL9005) and light grey (similar to RAL7035). Dark grey (similar to RAL7001) available upon request
- **Material:** Polyamide 6 with 30% fiberglass

Plastic Metric Locknuts without Flange (Order by Part No.)

M	Part Number		Dimensions			Pack
	Light Grey	Black	SW	H	ØD	
M12x1.5	184.512	184.412	18	5	19.5	100
M16x1.5	184.517	184.417	22	5	24.2	50
M20x1.5	184.520	184.420	26	6	28.6	50
M25x1.5	184.525	184.425	32	6	35.0	50
M32x1.5	184.532	184.432	41	7	46.1	25
M40x1.5	184.540	184.440	50	7	55.3	20

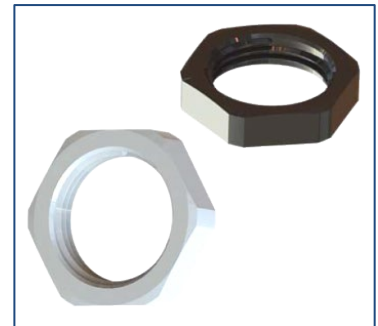

Information subject to change without notice - Dimensions in mm except where indicated

Plastic Pg Locknuts without Flange (Order by Part No.)

Pg	Part Number		Dimensions			Pack
	Light Grey	Black	SW	H	ØD	
Pg7	184.507	184.407	19	5	21	500
Pg9	184.509	184.409	22	5	24	50
Pg11	184.511	184.411	24	5	26	50
Pg13.5	184.513	184.413	27	6	29	50
Pg16	184.516	184.416	30	6	33	50
Pg21	184.521	184.421	36	7	39	25
Pg29	184.529	184.429	46	7	50	20
Pg36	184.536	184.436	60	8	66	10
Pg42	184.542	184.442	65	8	72	10
Pg48	184.548	184.448	70	8	78	10

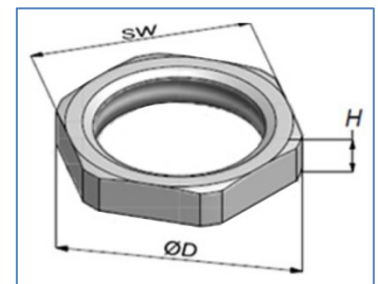

Information subject to change without notice - Dimensions in mm except where indicated



Accessories - Brass Locknuts

Metric and Pg available in standard and EMC versions; NPT and BSP available in standard versions.

Features and specifications:

- Operating Temperature: -60 to 200°C
- Material: Brass, nickel plated

Brass Metric Locknuts (Order by Part No.)

M	Standard Part No.	Pack	EMC Part No.	EMC Pack	SW
M12x1.5	184.712	100	—	—	15
M16x1.5	184.717	50	184.917	100	19
M20x1.5	184.720	50	184.920	100	24
M25x1.5	184.725	25	184.925	100	30
M32x1.5	184.732	20	184.932	50	36
M40x1.5	184.740	10	184.940	20	46
M50x1.5	184.751	5	184.951	10	60
M63x1.5	184.763	10	184.963	10	70
M72x2.0	184.772	10	—	—	77
M75 x1.5	184.776	5	—	—	80
M80x2	184.780	5	—	—	90
M85x2	184.785	5	—	—	95
M90x2	184.790	5	—	—	100
M100x2	184.800	1	—	—	110
M110x2?	184.810	1	—	—	125



Information subject to change without notice
All dimensions in mm except where indicated

Brass Pg Locknuts (Order by Part No.)

Pg	Standard Part No.	Pack	EMC Part No.	EMC Pack	SW
Pg7	184.707	50	184.907	100	15
Pg9	184.709	50	184.909	100	18
Pg11	184.711	50	184.911	100	21
Pg13.5	184.713	50	184.913	100	23
Pg16	184.716	50	184.916	50	26
Pg21	184.721	20	184.921	10	32
Pg29	184.729	20	184.929	10	41
Pg36	184.736	10	184.936	10	51
Pg42	184.742	10	184.942	10	60
Pg48	184.748	10	184.948	10	64

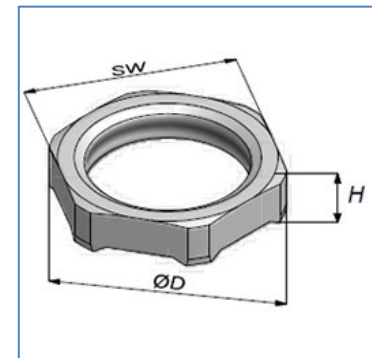

Information subject to change without notice
All dimensions in mm except where indicated

Brass NPT Locknuts (Order by Part No.)

NPT	Part No.	SW	H	Pack
3/8" NPT	184.738	22	5	50
1/2" NPT	184.750	24	6	50
3/4" NPT	184.775	30	7	20
1" NPT	184.791	36	5	20
1-1/4" NPT	184.794	45	4.7	20
1-1/2" NPT	184.796	60	7.1	5
2" NPT	184.798	74	8.75	5

Information subject to change without notice
All dimensions in mm except where indicated

Accessories - Stainless Steel Locknuts

Metric and NPT available in standard versions.

Features and specifications:

- Operating Temperature: -20 to 100° C
- Material: Stainless Steel 1.4305 (AISI 303)

Stainless Steel Metric Locknuts (Order by Part No.)

M	Standard Part No.	SW	H	Pack
M12x1.5	184.612	15	3	50
M16x1.5	184.617	19	3	50
M20x1.5	184.620	24	3.5	50
M25x1.5	184.625	30	3.5	25
M32x1.5	184.632	35	4.5	20
M40x1.5	184.640	45	4.5	20
M50x1.5	184.651	55	5.5	15
M63x1.5	184.663*	70	6	10
M72x2	184.672*	77	7	5
M75 x1.5	184.776*	80	8	1

Information subject to change without notice
All dimensions in mm except where indicated
* available upon request

Stainless Steel NPT Locknuts (Order by Part No.)

NPT	Part No.	SW	H	Pack
3/8" NPT	184.638	20	3	50
1/2" NPT	184.650	24	4	50
3/4" NPT	184.675	30	4	20
1" NPT	184.691	36	5	20

Information subject to change without notice
All dimensions in mm except where indicated

Accessories - Plastic Threaded Stopping Plugs

Blind stops are used to temporarily or permanently seal a hole in a panel or machine. Use the corresponding plastic locknut when the hole is not threaded. Sealing quality can be improved by means of an additional sealing washer, mounted between the gland and the panel.

Available in Metric, Pg and NPT thread.

Features and specifications:

- **Operating Temperature:** -20 to 100°C (permanent)
- **Standard colours:** Black (similar to RAL9005) and light grey (similar to RAL7035)
- **Material:** Polyamide 6

Plastic Threaded Stopping Plugs (Order by Part No.)

M/Pg/ NPT	Part No.		Dimensions (mm)				Pack
	Light Grey	Black	TD	TL	H	ØD	
Metric thread							
M12x1.5	188.012	188.112	12	6	4.5	15.0	100
M16x1.5	188.017	188.117	16	7	4.5	20.0	50
M20x1.5	188.020	188.120	20	7	5.5	24.0	50
M25x1.5	188.025	188.125	25	7.5	5.0	30.0	50
M32x1.5	188.032	188.132	32	9.5	4.0	39.0	25
M40x1.5	188.040	188.140	40	6	6.5	46.5	25
M50x1.5	188.051	188.151	50	10	4.0	57.0	10
M63x1.5	188.063	188.163	62	12	18.5	69.5	10
Pg Thread							
Pg7	188.007	188.107	12.5	6	2.0	15	100
Pg9	188.009	188.109	15.2	6	2.5	19	100
Pg11	188.011	188.111	18.6	6	2.5	22	50
Pg13.5	188.013	188.113	20.4	6	2.5	25	50
Pg16	188.016	188.116	22.5	6	3.0	27	50
Pg21	188.021	188.121	28.3	8	4.0	33	25
Pg29	188.029	188.129	37.0	8	3.5	44	25
Pg36	188.036	188.136	47.0	10	4.0	55	25
Pg42	188.042	188.142	54.0	10	5.0	62	10
Pg48	188.048	188.148	69.3	12	5.0	69	10
NPT/BSP Thread							
3/8" BSP	188.037●	—	16	7.5	6.0	18.0	100
1/2" NPT	—	188.150	20.0	7.0	4.5	25.0	50
1/2" BSP	188.049●	—	20.5	11.0	6.0	22.5	50

Information subject to change without notice
 ● hexagonal head

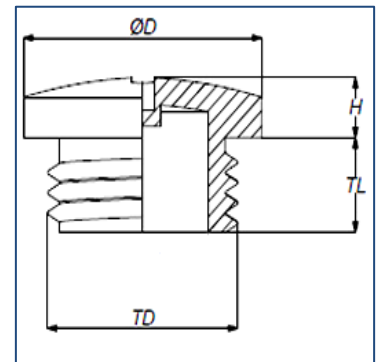

Accessories - Brass Threaded Stopping Plugs

Blind stops are used to temporarily or permanently seal a hole in a panel or machine. Use the correspondent plastic locknut when the hole is not threaded. Sealing quality can be improved by means of an additional sealing washer, mounted between the gland and the panel.

Features and specifications:

- Round heads except where indicated
- **Operating Temperature:** -60 to 200°C
- **Material:** Brass, nickel plated

Brass Threaded Stopping Plugs (Order by Part No.)

M/Pg/ NPT	Part No.	Dimensions (mm)				Pack
		TD	TL	H	ØD	
Metric thread						
M12x1.5	188.712	12	5.0	3.0	16	50
M16x1.5	188.717	16	6.0	3.0	20	50
M20x1.5	188.720	20	6.5	2.5	24	10
M20x1.5	188.720H	20	7.0	3.3	23/25.5	10
M25x1.5	188.725	25	7.7	3.0	28	10
M32x1.5	188.732	32	8.0	3.1	34.8	5
M40x1.5	188.740	40	8.0	4.0	43	1
M50x1.5	188.751	50	9.5	4.3	55	1
M63x1.5	188.763	63	10.0	5.0	62	1
Pg Thread						
Pg7	188.707	12.5	5.0	2.5	14	50
Pg9	188.709	15.2	6.0	2.5	17	50
Pg11	188.711	18.6	6.0	2.5	20	50
Pg13.5	188.713	20.4	6.0	3.0	22	50
Pg16	188.716	22.5	6.5	3.0	24	10
Pg21	188.721	28.3	7.0	3.8	30	10
Pg29	188.729	37.0	8.5	3.0	34	5
Pg36	188.736	47.0	9.0	4.5	50	5
Pg42	188.742	54.0	9.8	4.0	57	1
Pg48	188.748	59.3	10.5	4.0	64	1
NPT Thread (Hexagonal Heads)						
3/8" NPT	188.738H	17.1	15.0	3.0	19/21	25
1/2" NPT	188.750H	21.2	15.5	3.1	23.1/22.5	10
3/4" NPT	188.775H	26.7	21.0	4.5	29.2/32.5	5
1" NPT	188.791H	32.2	25.0	4.5	36/40	1
1 1/4" NPT	188.794H*	42.0	25.0	4.0		1
1 1/2" NPT	188.796H*	48.1	26.0	5.0		1
2" NPT	188.798H*	60.1	27.0	6.0		1

Information subject to change without notice

H Hexagonal head

* available upon request

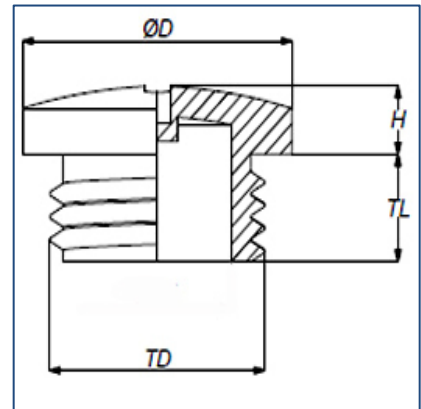













Accessories - Snap Bushings & Plugs

Snap bushings are used to protect wires and cables passing through panel openings. Hole-plugs are used for temporary closing round holes in a panel.

Features and specifications:

- Lock into hole firmly with fingertip pressure
- Colour: Black
- Material: Polyamide 6

Grommets & Plugs (Order by Part No.)

Part No.	Description	Diameter (mm)	Cutout (mm)	Inside Ø (mm)	Head outside Ø (mm)	Pack Qty	Approvals
111.148	Snap bushing	7.8	7.8	6.8	9.8	100	
111.149	Snap bushing	9.5	9.5	6.4	12.0	100	
111.150	Snap bushing	12.7	12.7	8.0	15.0	100	
111.152	Snap bushing	15.9	15.9	12.7	18.6	100	
111.153	Snap bushing	19.0	19.0	14.3	21.7	100	
111.154	Snap bushing	22.2	22.2	17.5	24.2	100	
111.155	Snap bushing	25.5	25.5	19.1	28.5	100	
111.156	Snap bushing	30.0	30.0	24.1	33.3	100	
111.157	Snap bushing	31.5	31.5	23.8	34.6	100	
111.158	Snap bushing	38.1	38.1	29.0	42.1	100	
111.159	Snap bushing	44.5	44.5	35.4	47.8	10	
111.160	Snap bushing	50.1	50.1	41.6	54.6	10	
111.162	Snap hole-plug	16.0	16.0	–	19.5	10	–
111.163	Snap hole-plug	19.0	19.0	–	22.9	10	–
111.164	Snap hole-plug	22.5	22.5	–	25.8	10	–
111.165	Snap hole-plug	25.0	25.0	–	29.0	10	–
111.166	Snap hole-plug	30.0	30.0	–	34.2	10	–
111.167	Snap hole-plug	38.0	38.0	–	42.1	10	–
111.174	Cable guiding snap bushing	22.5	22.5	–	25.6	100	–

Information subject to change without notice - All dimensions in mm



Accessories - Sealing Washers & O-Rings

Sealing washers and O-rings add extra protection against liquid leakage between the body of the gland and the enclosure. Use in areas of added risk of wash-down.

Features and specifications:

- **Operating Temperature:** -20 to 80°C (polyethylene), -30 to 100°C (NBR)
- **Standard colours:** White(similar to RAL9003) (polyethylene) and Black (similar to RAL9005, NBR)
- **Material:** High Density Polyethylene (HDPE) or Nitrile Rubber (NBR). Silicone and Viton available

Sealing Washers & O-Rings (Order by Part No.)

M/Pg/NPT/ISO				Sealing Washer Part No.		O-Ring Part No.	Pack
Metric	Pg	NPT	BSP/ISO	NBR	HDPE	NBR	
M12x1.5	–	–	–	185.880	185.579	–	100
–	Pg7	¼”NPT	¼”BSP	185.891	185.580	–	100
–	Pg9	–	–	185.892	185.581	–	100
M16x1.5	–	–	–	185.881	185.571	–	100
–	Pg11	⅜”NPT	⅜”BSP	185.893	185.582	–	100
M20x1.5	–	–	–	185.882	185.572	185.413 * 185.420 *	100
–	Pg13.5	½”NPT	½”BSP	185.894	185.583	–	100
–	Pg16	–	–	185.895	185.584	185.416	100
M25x1.5	–	–	–	185.883	185.573	185.425	100
–	Pg21	¾”NPT	¾”BSP	185.896	185.585	185.421	50
M32x1.5	–	–	–	185.884	185.574	–	50
–	Pg29	1”NPT	1”BSP	185.897	185.586	185.429	25
M40x1.5	–	–	–	185.885	185.575	–	50
–	Pg36	1 ½”NPT	1 ½”BSP	185.898	185.587	–	25
M50x1.5	–	–	–	185.886	185.576	–	25
–	Pg42	1 ¾”NPT	1 ¾”BSP	185.899	185.588	–	25
M63x1.5	–	–	–	185.887	185.577	–	25
–	Pg48	–	–	185.900	185.589	–	10

* 185.413 dimensions are 22x18x2mm, 184.420 dimensions are 21x18x1.5mm
Information subject to change without notice





Accessories - Multi-hole Seals

Use a multi-hole seal in those applications where more than one non-terminated cable or wire needs to be inserted into the same cutout. The seals below are to be used with standard industrial domed glands by ITC (plastic or brass) after having removed the original internal rubber seal.

Features and specifications:

- Operating Temperature: -20 to 80°C (permanent)
- Material: Nitrile Rubber (NBR). Silicone and Viton available

Multi-Hole Seals (Order by Part No.)

M/Pg/NPT				Part No.	Holes		Dimensions		Pack
Metric Plastic	Metric Brass	Pg	NPT		#	Dia.	H	ØD	
—	—	Pg9	—	189.223	2	3	7.5	10.6	50
—	—	Pg9	—	189.232	3	2	7.5	10.6	50
—	—	Pg9	—	189.242	4	2	7.5	10.6	50
—	—	Pg9	—	189.243	4	3	7.5	10.6	50
M16	M16 (LH)	Pg11	3/8"	189.324	2	4	8.5	13.3	50
M16	M16 (LH)	Pg11	3/8"	189.334	3	4	8.5	13.3	50
M16	M16 (LH)	Pg11	3/8"	189.335	3	5	8.5	13.3	50
M20	M20 (LH)	Pg13.5	1/2"	189.425	2	5	8.5	15.3	50
M20	M20 (LH)	Pg13.5	1/2"	189.426	2	6	8.5	15.3	50
M20	M20 (LH)	Pg13.5	1/2"	189.434	3	4	8.5	15.3	50
M20	M20 (LH)	Pg13.5	1/2"	189.435	3	5	8.5	15.3	50
M20 (LH)	M20 (LH)	Pg13.5	1/2"	189.444	4	3.0-4.2	8.4	16.0	50
M20 (LH)	—	Pg16	1/2"	189.523	2	2.0-3.0	9.0	17.5	50
M20 (LH)	—	Pg16	1/2" (LH)	189.524	2	4	9.0	17.4	50
M20 (LH)	—	Pg16	1/2" (LH)	189.525	2	5	10.0	17.4	50
M20 (LH)	—	Pg16	1/2" (LH)	189.526	2	6	9.0	17.4	50
M20 (LH)	—	Pg16	1/2" (LH)	189.534	3	4	9.0	17.4	50
M20 (LH)	—	Pg16	1/2" (LH)	189.536	3	6	9.0	17.4	50
M20 (LH)	—	Pg16	1/2" (LH)	189.544	4	4	9.0	17.4	50
M20 (LH)	—	Pg16	1/2" (LH)	189.545	4	5	9.0	17.4	50
M20 (LH)	—	Pg16	1/2" (LH)	189.554	5	4	9.0	17.4	50

LH = large head # = number of holes Information subject to change without notice - Dimensions in mm except where indicated
Upon request, ITC can also supply glands already equipped with standard multi-hole seals, or with custom-specified multi-hole seals

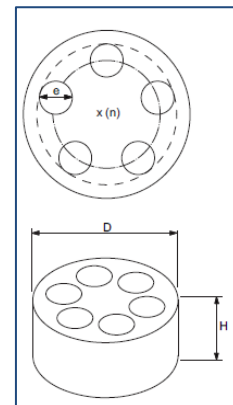



Multi-Hole Seals (Order by Part No.)

M/Pg/NPT				Part No.	Holes		Dimensions		Pack
Metric Plastic	Metric Brass	Pg	NPT		#	Dia.	H	ØD	
M25	M25 (LH)	Pg21	3/4"	189.627	2	7	11.0	22.2	25
M25	M25 (LH)	Pg21	3/4"	189.628	2	8	11.0	22.2	25
M25	M25 (LH)	Pg21	3/4"	189.629	2	9	11.0	22.2	25
M25	M25 (LH)	Pg21	3/4"	189.637	3	7	11.0	22.2	25
M25	M25 (LH)	Pg21	3/4"	189.638	3	8	11.0	22.2	25
M25	M25 (LH)	Pg21	3/4"	189.647	4	7	11.0	22.2	25
M25	M25 (LH)	Pg21	3/4"	189.655	5	5	11.0	22.2	25
M25	M25 (LH)	Pg21	3/4"	189.663	6	2.6-3.6	11.2	22.8	25
M25	M25 (LH)	Pg21	3/4"	189.664	6	4	11.9	22.9	25
M25	M25 (LH)	Pg21	3/4"	189.681	8	1.5	12.0	22.9	25
M32	M32 (LH)	Pg29	1"	189.728	2	8	14.0	30.4	20
M32	M32 (LH)	Pg29	1"	189.729	2	9	14.0	30.4	20
M32	M32 (LH)	Pg29	1"	189.735	3	4.8-6.2	14.4	30.4	20
M32	M32 (LH)	Pg29	1"	189.739	3	7.7-10.0	14.7	30.0	20
M32	M32 (LH)	Pg29	1"	189.745	4	4.8-5.2	14.3	30.0	20
M32	M32 (LH)	Pg29	1"	189.748	4	8	14.0	30.4	20
M32	M32 (LH)	Pg29	1"	189.755	5	4.6-6	14.3	30.3	20
M32	M32 (LH)	Pg29	1"	189.758	5	8.5	14.0	30.4	20
M32	M32 (LH)	Pg29	1"	189.765	6	3.6-5.2	14.4	30.0	20
M32	M32 (LH)	Pg29	1"	189.775	8	4.6-6.0	14.4	30.0	20
M32	M32 (LH)	Pg29	1"	189.784	8	4.0	13.0	30.1	20
M32	M32 (LH)	Pg29	1"	189.785	8	5	13.0	29.8	20
M40	M40 (LH)	Pg36	1 1/4"	189.820	2	11-13	17.3	38.8	10
M40	M40 (LH)	Pg36	1 1/4"	189.829	2	7-9	17.0	38.6	10
M40	M40 (LH)	Pg36	1 1/4"	189.838	3	6.5-8.3	17.0	38.6	10
M40	M40 (LH)	Pg36	1 1/4"	189.839	3	7.7-10	17.0	38.6	10
M40	M40 (LH)	Pg36	1 1/4"	189.840	4	10-12	17.2	41.5	10
M40	M40 (LH)	Pg36	1 1/4"	189.858	5	6.5-8	17.2	41.5	10
M50	M50	Pg42	1 1/2"	189.938	3	6.5-8.3	16.6	41.8	10
M50	M50	Pg42	1 1/2"	189.958	5	6.5-8.3	16.6	41.8	10

LH = large head # = number of holes Information subject to change without notice - Dimensions in mm except where indicated
Upon request, ITC can also supply glands already equipped with standard multi-hole seals, or with custom-specified multi-hole seals

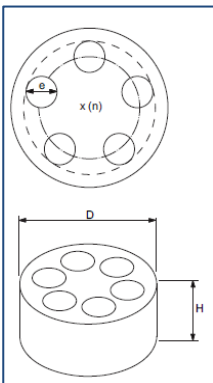

Accessories - Flat Cable Seals

The flat cable seals are designed to be inserted in place of the original seals of ITC plastic cable glands.

Features and specifications:

- **Operating temperature:** -20 to 90°C
- **Material:** thermoplastic elastomer
- **Colour:** black

Flat Cable Seals Order by Part No.)

M/Pg/NPT *			Part No.	Cable Size (mm)^	Cable Size (in)^	Pack
Metric	Pg	NPT				
M20 (LH)	Pg16	½" (LH)	189.510-FC126	11.8 x 6.5mm	0.465 x 0.266"	50
M20 (LH)	Pg16	NPT ½" (LH)	189.510-FC136	13.8 x 6.0mm	0.543 x 0.236"	50
M25	Pg21	¾"	189.610-FC126	11.8 x 6.5mm	0.465 x 0.266"	50
M25	Pg21	¾"	189.610-FC136	13.8 x 6.0mm	0.543 x 0.236"	50
M32	Pg29	1"	189.10-FC136	13.8 x 6.0mm	0.543 x 0.236"	25
M32	Pg29	1"	189.710-FC218	21.8 x 8.0mm	0.858 x 0.315"	25

Information subject to change without notice.

* refer to ITC standard plastic cable glands. ^ +/- 10%

LH - large head

Accessories - Custom Cable Seals

Upon request, ITC can also manufacture seals for special flat, ribbon or custom-shaped cables, designed to fit ITC's Cable Glands. Contact ITC for such special applications.



Accessories - Special Seals for ASI Cables

ITC provides, from stock, specially designed seals for ASI (Actuator-Sensor Interface) cables. The seals below are to be used with standard industrial domed glands by ITC (either plastic or brass) after having removed the original internal rubber seal.



Features and specifications:

- Operating Temperature: -30 to 100°C (permanent)
- Material: Evoprene TPE

Special Seals (Order by Part No.)

M/Pg/NPT			ASI cables	Part No.	Dimensions (mm)		Pack
Metric	Pg	NPT	N		H	ØD	
M20x1.5 (NH)	Pg13.5	1/2" (NH)	1	191.511	9.0	15.0	10
M20x1.5 (NH)	Pg13.5	1/2" (NH)	2	191.512	9.0	15.0	10
M20x1.5 (LH)	Pg16	1/2" (LH)	1	191.521	9.3	19.8	10
M20x1.5 (LH)	Pg16	1/2" (LH)	2	191.522	9.3	19.8	10

NH = normal head LH = large head. Information subject to change without notice

Accessories - Hole Plugs & Temporary Sealing Plugs

Hole plugs are used to block a hole in a multi-hole seal and maintain the IP rating.

Features and specifications:

- Operating Temperature: -20 to 90°C (permanent)
- Material: Polyamide 6 (light grey / K = BLACK)

Multi-hole Seal Plugs (Order by Part No.)

Part No.	Diameter	Length	Pack
188.902K	2	15	100
188.903	3	8	100
188.903K	3	15	100
188.904	4	8	100
188.904K	4.3	15	100
188.905	5	13	50
188.905K	5	15	50
188.906	6	13	50
188.906K	6.2	15	50
188.907	7	13	50
188.907	7.2	15	50
188.908	8	17	50
188.908K	8	15	50
188.909K	9	15	50



Information subject to change without notice
All dimensions in mm except where indicated

Temporary blocking plugs are used to seal an installed cable gland before the wire and cable is passed inside it. Their mushroom shape prevents the plug from being inserted too deep and facilitates removal. **Do not remove the original internal rubber seal!**

Temporary Blocking Plugs (Order by Part No.)

Part No.	Plug Ø.A. (mm)	Pack
188.207	4.5	10
188.209	8	10
188.211	9.5	10
188.213	10	10
188.216	12.5	10
188.225	16	10
188.232	19	10
188.236	31.5	10
188.251	35	10
188.263	43.5	5



Information subject to change without notice
Ø.A. - diameter of the body of the plug, not the cap

Ingress Protection (IP)

Ingress protection for Low Voltage Enclosures is defined by the European Standard IEC 60529 as a code comprising 2 letters (IP) and 2 digits.

The first digit (between 0 and 6) indicates the degree of protection provided with respect to the equipment contained in the enclosure. The second digit (between 0 and 8) indicates the degree of protection with respect to the harmful effects of liquid penetration. The ratings for water ingress are not cumulative beyond IPX6. Since the definitions are different, there is no exact equivalence between European IP Ingress Protection ratings, and North American NEMA ratings.

1st digit

IP	Description
0	No protection
1	Protection against solid objects greater than 50mm
2	Protection against solid objects greater than 12.5mm
3	Protection against solid objects greater than 2.5mm
4	Protection against solid objects greater than 1.0mm
5	Protection against penetration of dust
6	Dust-tight

2nd digit

IP	Description
0	No protection
1	Protection against dripping water
2	Protection against dripping water when tilted up to 15°
3	Protection against spraying water
4	Protection against splashing water
5	Protection against water jets
6	Protection against heavy seas
7	Protection against the effects of immersion
8	Protection against submersion
9K	Protection against high pressure, high temperature liquid (80°C) or steam

Example: an enclosure rated **IP54** is protected against penetration of dust, and against splashing water.

Characteristics of Plastic Materials

Resistance to chemicals and solvents, UL 94 rating and temperature

	Weak acids	Strong acids	Weak alkali	Strong alkali	Alcohol	Gasoline	Mineral oil	Ammonia	Vegetable fats/oils	Animal fats	UL94 rating	Temp °C rating
Polystyrene	●	⊙	●	●	●	○	●	●	●	○	HB	-20/+70
Polycarbonate	●	○	○	○	⊙	○	●	○	●	●	V2	-40/+135
Polyamide 6	○	○	●	●	●	⊙	●	●	⊙	●	V2	-30/+100
Polyamide 6 w/fiberglass	○	○	●	●	●	⊙	●	●	⊙	●	HB	-30/+110
Chloroprene	⊙	⊙	⊙	●	⊙	●	⊙	⊙	⊙	●	—	-25/+100
NBR	●	⊙	⊙	○	●	●	●	⊙	●	●	—	-25/+120
Silicon rubber	○	○	○	○	●	⊙	○	⊙	⊙	—	—	-50/+230
Polyoxymethylene	○	○	⊙	—	●	●	⊙	⊙	⊙	—	HB	-30/+100
PVC	⊙	⊙	⊙	⊙	●	⊙	⊙	○	●	●	V0	-20/+130
Viton (Fluoro Elastomer)	●		●		●		●	○	●	●	—	-30/+230

● = Very Good, ⊙ = Fair, ○ = Poor, - = test results not available
 The information above is given for average applications and for general use only

Contact ITC for other types of Glands not covered in this catalog including:

- Glands for **railway** use
- Series 4 EMC glands
- **Hazardous locations** glands and blind plugs
- **Hygienic** glands
- Strap Clamps
- **DETAUltra Cable Entry Systems** - split cable glands and cable passing frames

Thread Tables

M	Pitch (mm)	D1 (mm)	Core D2 (mm)	Cut-out (mm)	Recommended Cut-out (mm)	Recommended Cut-out (in)
M10 x 1.0	1.0	10	9.0	10.2	10.5	0.41
M12 x 1.5	1.5	12	10.5	12.2	12.5	0.5
M16 x 1.5	1.5	16	14.5	16.2	16.5	0.65
M20 x 1.5	1.5	20	18.5	20.2	20.5	0.81
M25 x 1.5	1.5	25	23.5	25.2	25.5	1.0
M32 x 1.5	1.5	32	30.5	32.2	32.5	1.3
M40 x 1.5	1.5	40	38.5	40.2	40.5	1.6
M50 x 1.5	1.5	50	48.5	50.2	50.5	1.99
M63 x 1.5	1.5	63	61.5	63.2	63.5	2.5

METRIC ISO Thread
According to EN 60423

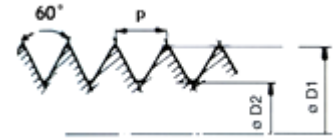

Pg	Pitch (mm)	D1 (mm)	Core D2 (mm)	Cut-out (mm)	Recommended Cut-out (mm)	Recommended Cut-out (in)
Pg 7	1.270	12.5	11.28	12.7	13	0.51
Pg 9	1.410	15.2	13.86	15.4	16	0.63
Pg 11	1.410	18.6	17.26	18.8	19	0.75
Pg 13.5	1.410	20.4	19.06	20.7	21	0.83
Pg 16	1.410	22.5	21.16	22.8	23	0.91
Pg 21	1.588	28.3	26.78	28.6	29	1.14
Pg 29	1.588	37.0	35.48	37.4	37	1.46
Pg 36	1.588	47.0	45.48	47.5	42	1.65
Pg 42	1.588	54.0	52.48	54.5	47	1.85
Pg 48	1.588	59.3	57.78	59.8	54	2.13

PG Thread
According to DIN 40430

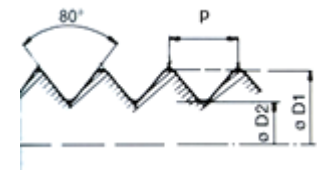

NPT	Pitch (mm)	D1 (mm)	Threads /inch	Cut-out (mm)	Recommended Cut-out (mm)	Recommended Cut-out (in)
3/8"	1.411	17.055	18	17.2	17.5	0.69
1/2"	1.814	21.223	14	21.4	21.5	0.85
3/4"	1.814	26.568	14	26.9	27.0	1.07
1"	2.208	33.228	11 1/2"	33.7	34.5	1.36
1 1/4"	2.208	41.985	11 1/2"	42.4	43.0	1.69
1 1/2"	2.208	48.054	11 1/2"	48.5	49.2	1.93
2"	2.208	60.092	11 1/2"	60.2	61.0	2.40

NPT Thread

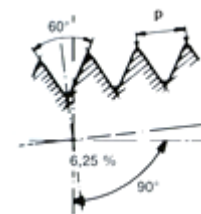

Split Cable Glands

Split cable glands permit the passage of pre-terminated cables and wires while providing sealing and strain relief and are composed of a frame which can be separated in 2 parts, and of grommets (inserts) which can accommodate the cable or wire before being securely inserted in the frame.

All split cable frames are supplied with the corresponding locknut.

ITC offers the following models of split cable gland frames:

- **OSF:**
 - **Assembly:** Snap
 - **Sizes:** M16, M20, M25, M32
 - **Ingress Protection:** IP54, NEMA12, IK10

- **DESCCLICK:**
 - **Assembly:** Snap
 - **Sizes:** M20, M25, M32, M50
 - **Ingress Protection:** IP54, NEMA12, IK10

- **DESPRED**
 - **Assembly:** Screw
 - **Sizes:** M25, M32, M63
 - **Ingress Protection:** IP66, NEMA4X, IK10

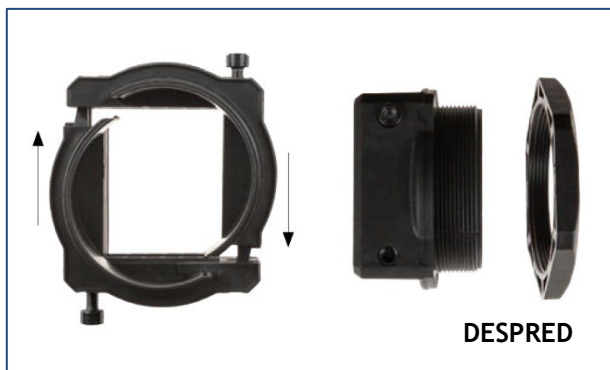
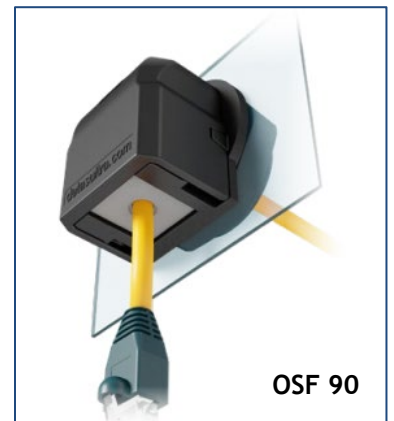

Contact ITC for details, or consult the Cable Entry Systems catalog EC-2114

Thread Adapters

ITC provides a wide variety of adapters, enlargers and reducers, both in brass and plastic, to convert knockouts or hubs from one style to another, or convert to a larger / smaller size of the same style.

Available in Metric, Pg and NPT threads.

Brass thread adapters are made of brass, nickel-plated, RoHS compliant, and are available in various styles:

- Hex wrenching flats - add "H" to the part number when ordering i.e. 194.501H
- ○ Round or Knurled

Plastic thread adapters are made either of Polyamide (plastic) or polycarbonate, depending on model and size. They are light grey unless otherwise indicated with '^'.

Metric thread to Metric thread

Male thread (from)	Female thread (to)	Part No. (Brass)	Part No. (Plastic)
M12	M16	194.501 ○●	193.501
M16	M12	194.510 ○●	193.510
M16	M20	194.512 ●	193.512
M20	M12	194.520 ●	193.520^
M20	M16	194.521 ○●	193.521^
M20	M25	194.523 ○●	193.523
M25	M12	194.530 ○	193.530
M25	M16	194.531 ○	193.531^
M25	M20	194.532 ○●	193.532^
M25	M32	194.534 ○●	193.534
M32	M16	—	193.541
M32	M20	194.542 ○●	193.542
M32	M25	194.543 ○	193.543
M32	M40	194.545 ○●	193.545
M40	M20	—	193.552
M40	M25	194.553 ●	193.553
M40	M32	194.554 ○	193.554^
M40	M50	194.556 ○●	193.556
M50	M20	—	193.562
M50	M25	—	193.563
M50	M32	194.564 ○	193.564
M50	M40	194.565 ○●	193.565^
M50	M63	194.567 ○●	193.567
M63	M32	—	193.574
M63	M40	194.575 ○	193.575
M63	M50	194.576 ○	193.576^

Information subject to change without notice
^ black



Metric thread to NPT thread

Male thread (from)	Female thread (to)	Part No. (Brass)	Part No. (Plastic)
M12	3/8" NPT	—	—
M16	3/8" NPT	194.611 ●	—
M16	1/2" NPT	194.612 ○●	193.612^
M20	1/2" NPT	194.622 ○●	193.622^
M20	3/4" NPT	194.623 ●	—
M25	1/2" NPT	194.632 ●	—
M25	3/4" NPT	194.633 ○●	—
M25	1" NPT	194.634 ●	—
M32	3/4" NPT	194.643 ○●	—
M32	1" NPT	194.644 ○●	—
M40	3/4" NPT	194.653 ●	—
M40	1 1/4" NPT	194.655 ○●	—
M40	1 1/2" NPT	194.656 ●	—
M50	1 1/2" NPT	194.666 ●	—
M63	1 1/2" NPT	194.676 ●	—

Information subject to change without notice
^ black

Metric thread to Pg thread

Male thread (from)	Female thread (to)	Part No. (Brass)	Part No. (Plastic)
M16	Pg11	194.712 ○	—
M20	Pg9	194.721 ○●	—
M20	Pg11	194.722 ○●	193.722
M20	Pg13.5	194.723 ○●	193.723
M20	Pg16	194.724 ○●	193.724^
M25	Pg16	194.734 ○●	193.734
M25	Pg21	194.735 ○●	193.735
M32	Pg16	194.744 ○●	—
M32	Pg21	194.745 ○	193.745
M32	Pg29	194.746 ●	193.746
M40	Pg29	194.756 ●	193.756
M40	Pg36	194.757 ○	—
M50	Pg36	194.767 ○●	—
M50	Pg42	194.768 ○●	—
M63	Pg36	194.777 ●	—
M63	Pg48	194.779 ○	—

Information subject to change without notice
^ black

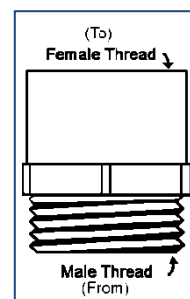

Pg thread to Pg thread

Male thread (from)	Female thread (to)	Part No. (Brass)	Part No. (Plastic)
Pg7	Pg9	194.001 ⊙	193.001
Pg9	Pg7	194.010 ⊙●	193.010
Pg9	Pg11	194.012 ⊙	193.012
Pg9	Pg13.5	194.013 ⊙	—
Pg11	Pg7	194.020 ⊙	193.020
Pg11	Pg9	194.021 ⊙	193.021
Pg11	Pg13.5	194.023 ⊙●	193.023
Pg13.5	Pg7	194.030 ⊙	193.030
Pg13.5	Pg9	194.031 ⊙	193.031
Pg13.5	Pg11	194.032 ⊙	193.032
Pg13.5	Pg16	194.034 ⊙●	193.034
Pg13.5	Pg21	194.035 ⊙	—
Pg16	Pg9	194.041 ⊙	193.041
Pg16	Pg11	194.042 ⊙	193.042
Pg16	Pg13.5	194.043 ⊙	193.043
Pg16	Pg21	194.045 ⊙●	193.045
Pg21	Pg11	194.052 ⊙	193.052
Pg21	Pg13.5	194.053 ⊙	193.053
Pg21	Pg16	194.054 ⊙	193.054
Pg21	Pg29	194.056 ⊙●	193.056
Pg29	Pg13.5	—	193.063
Pg29	Pg16	194.064 ⊙	193.064
Pg29	Pg21	194.065 ⊙	193.065
Pg29	Pg36	194.067 ⊙●	193.067
Pg36	Pg16	—	193.074
Pg36	Pg21	194.075 ⊙●	193.075
Pg36	Pg29	194.076 ⊙	193.076
Pg36	Pg42	194.078 ⊙	193.078
Pg42	Pg21	—	193.085
Pg42	Pg29	194.086 ⊙	193.086
Pg42	Pg36	194.087 ⊙●	193.087
Pg42	Pg48	194.089 ⊙	193.089
Pg48	Pg29	—	193.096
Pg48	Pg36	194.097 ⊙	193.097
Pg48	Pg42	194.098 ●	193.098

Information subject to change without notice

NPT thread to Metric thread

Male thread (from)	Female thread (to)	Part No. (Brass)	Part No. (Plastic)
3/8"NPT	M20	194.312 ●	—
1/2"NPT	M16	194.321 ●	—
1/2"NPT	M20	194.322 ⊙●	—
3/4"NPT	M25	194.333 ●	—

Information subject to change without notice



Pg thread to NPT thread

Male thread (from)	Female thread (to)	Part No. (Brass)	Part No. (Plastic)
Pg7	3/8"NPT	194.101 ●	—
Pg9	1/2"NPT	194.112 ●	—
Pg11	3/8"NPT	194.121 ⊙●	—
Pg11	1/2"NPT	194.122 ⊙	193.122
Pg13.5	1/2"NPT	194.132 ⊙●	—
Pg16	1/2"NPT	194.142 ⊙●	193.142
Pg16	3/4"NPT	194.143 ●	193.143
Pg21	1/2"NPT	194.152 ●	193.152
Pg21	3/4"NPT	194.153 ⊙●	193.153
Pg21	1"NPT	194.154 ⊙●	—
Pg29	1"NPT	194.164 ⊙●	—
Pg29	1 1/4"NPT	194.165 ⊙●	—
Pg36	1 1/4"NPT	194.175 ⊙●	—
Pg36	1 1/2"NPT	194.176 ⊙●	—
Pg42	1 1/2"NPT	194.186 ⊙●	—
Pg48	1 1/2"NPT	194.196 ●	—
Pg48	2"NPT	194.197 ●	- Special order

Information subject to change without notice

Pg thread to Metric thread:

Male thread (from)	Female thread (to)	Part No. (Brass)	Part No. (Plastic)
Pg7	M16	—	193.801
Pg9	M12	—	193.810
Pg9	M16	—	193.811
Pg9	M20	—	193.812
Pg11	M16	—	193.821
Pg11	M20	—	193.822
Pg13.5	M16	—	193.831
Pg13.5	M20	194.832 ⊙●	193.832
Pg13.5	M25	—	193.833
Pg16	M20	194.842 ⊙●	193.842
Pg16	M25	194.843 ●	193.843
Pg21	M20	194.852 ⊙	—
Pg21	M25	194.853 ⊙●	193.853
Pg21	M32	194.854 ●	193.854
Pg29	M25	194.863 ⊙	—
Pg29	M32	—	193.864
Pg29	M40	194.865 ⊙●	193.865
Pg36	M40	—	193.875
Pg36	M50	194.876 ●	—
Pg42	M50	194.886 ●	193.886
Pg48	M63	—	193.897

Information subject to change without notice

NPT thread to Pg thread

Male thread (from)	Female thread (to)	Part No. (Brass)	Part No. (Plastic)
3/8"NPT	Pg9	—	193.411 [^]
1/2"NPT	Pg9	194.421 ●	—
1/2"NPT	Pg11	194.422 ●	—
1/2"NPT	Pg13.5	194.423 ⊙●	193.423 [^]
1/2"NPT	Pg16	194.424 ⊙●	—
3/4"NPT	Pg16	194.434 ●	—
3/4"NPT	Pg21	194.435 ● [^]	193.435 [^]
1"NPT	Pg16	194.444 ● [^]	—
1"NPT	Pg21	194.445 ●	—
1"NPT	Pg29	194.446 ●	193.446 [^]
1 1/4"NPT	Pg36	—	—
1 1/2"NPT	Pg42	—	193.468 [^]

Information subject to change without notice

[^] end of stock



ELECTRICAL COMPONENTS

416.663.7223
 www.itcproducts.com
 50 Mural St Unit 8
 Richmond Hill, ON L4B 1E4



DIN Rail



DIN Rail Accessories



Non-Metallic Enclosures



Hinged Enclosures



Thermal Management



PANEL Lighting



Multipole Connectors



Compact IP68 Connectors

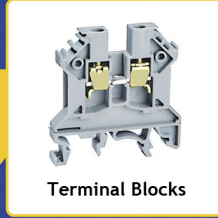

Terminal Blocks



Terminal Strips



22.5mm Pushbuttons



LED Indicators



Control Stations



Limit Switches



Micro Limit Switches



Safety Switches



Foot Switches

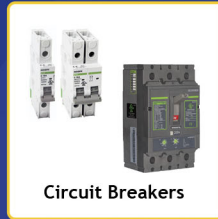

Circuit Breakers



IEC Contactors

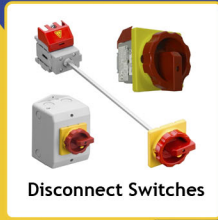

Disconnect Switches



Midget and CC Fuse Holders



Tower Lights



Power Continuity



Ferrules



Colour Coded Lugs



Crimp Terminals



Termination Kits



Cable Glands



Thread Adapters



Cable Entry Systems



Wire Management



DIN Rail Cutters



Assembly Tables



Cutting & Stripping



Crimping Tools



Hole Cutting & Punching Tools

SOME OF OUR MANUFACTURING PARTNERS

